

DS92LV010A

Bus LVDS 3.3/5.0V Single Transceiver

General Description

The DS92LV010A is one in a series of transceivers designed specifically for the high speed, low power proprietary bus backplane interfaces. The device operates from a single 3.3V or 5.0V power supply and includes one differential line driver and one receiver. To minimize bus loading the driver outputs and receiver inputs are internally connected. The logic interface provides maximum flexibility as 4 separate lines are provided (D_{IN}, DE, \overline{RE} , and R_{OUT}). The device also features flow through which allows easy PCB routing for short stubs between the bus pins and the connector. The driver has 10 mA drive capability, allowing it to drive heavily loaded backplanes, with impedance as low as 27 Ohms.

The driver translates between TTL levels (single-ended) to Low Voltage Differential Signaling levels. This allows for high speed operation, while consuming minimal power with reduced EMI. In addition the differential signaling provides common mode noise rejection of $\pm 1V$.

The receiver threshold is $\pm 100mV$ over a $\pm 1V$ common mode range and translates the low voltage differential levels to standard (CMOS/TTL) levels.

Features

- Bus LVDS Signaling (BLVDS)
- Designed for Double Termination Applications
- Balanced Output Impedance
- Lite Bus Loading 5pF typical
- Glitch free power up/down (Driver disabled)
- 3.3V or 5.0V Operation
- $\pm 1V$ Common Mode Range
- $\pm 100mV$ Receiver Sensitivity
- High Signaling Rate Capability (above 100 Mbps)
- Low Power CMOS design
- Product offered in 8 lead SOIC package
- Industrial Temperature Range Operation

Connection Diagram

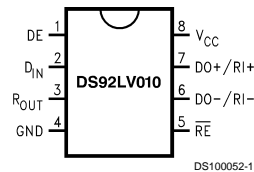

Order Number DS92LV010ATM
See NS Package Number M08A

Block Diagram

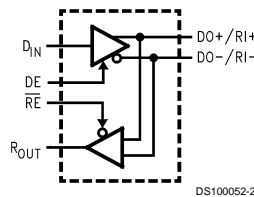

Absolute Maximum Ratings (Notes 1, 2)

If Military/Aerospace specified devices are required, please contact the National Semiconductor Sales Office/Distributors for availability and specifications.

Supply Voltage (V_{CC})	6.0V
Enable Input Voltage (DE, \overline{RE})	-0.3V to ($V_{CC} + 0.3V$)
Driver Input Voltage (DIN)	-0.3V to ($V_{CC} + 0.3V$)
Receiver Output Voltage (R_{OUT})	-0.3V to ($V_{CC} + 0.3V$)
Bus Pin Voltage (DO/RI±)	-0.3V to +3.9V
Driver Short Circuit Current	Continuous
ESD (HBM 1.5 kΩ, 100 pF)	>2.0 kV
Maximum Package Power Dissipation at 25°C	

SOIC	1025 mW
Derate SOIC Package	8.2 mW/°C
Storage Temperature Range	-65°C to +150°C
Lead Temperature (Soldering, 4 sec.)	260°C

Recommended Operating Conditions

	Min	Max	Units
Supply Voltage (V_{CC}), or	3.0	3.6	V
Supply Voltage (V_{CC})	4.5	5.5	V
Receiver Input Voltage	0.0	2.9	V
Operating Free Air Temperature	-40	+85	°C

DC Electrical Characteristics (Notes 2, 3)

$T_A = -40^\circ\text{C}$ to $+85^\circ\text{C}$ unless otherwise noted, $V_{CC} = 3.3V \pm 0.3V$

Symbol	Parameter	Conditions	Pin	Min	Typ	Max	Units	
V_{OD}	Output Differential Voltage	$R_L = 27\Omega$, Figure 1	DO+/RI+, DO-/RI-	140	250	360	mV	
ΔV_{OD}	V_{OD} Magnitude Change				3	30	mV	
V_{OS}	Offset Voltage			1	1.25	1.65	V	
ΔV_{OS}	Offset Magnitude Change				5	50	mV	
I_{OSD}	Output Short Circuit Current	$V_O = 0V$, $DE = V_{CC}$			-12	-20	mA	
V_{OH}	Voltage Output High	$V_{ID} = +100\text{ mV}$	$I_{OH} = -400\ \mu\text{A}$	R_{OUT}	2.8	3		V
		Inputs Open			2.8	3		V
		Inputs Shorted			2.8	3		V
		Inputs Terminated, $R_L = 27\Omega$			2.8	3		V
V_{OL}	Voltage Output Low	$I_{OL} = 2.0\text{ mA}$, $V_{ID} = -100\text{ mV}$			0.1	0.4	V	
I_{OS}	Output Short Circuit Current	$V_{OUT} = 0V$, $V_{ID} = +100\text{ mV}$		-5	-35	-85	mA	
V_{TH}	Input Threshold High	$DE = 0V$	DO+/RI+, DO-/RI-			+100	mV	
V_{TL}	Input Threshold Low			-100			mV	
I_{IN}	Input Current	$DE = 0V$, $V_{IN} = +2.4V$, or $0V$		-20	± 1	+20	μA	
		$V_{CC} = 0V$, $V_{IN} = +2.4V$, or $0V$		-20	± 1	+20	μA	
V_{IH}	Minimum Input High Voltage		DIN, DE, \overline{RE}	2.0		V_{CC}	V	
V_{IL}	Maximum Input Low Voltage			GND		0.8	V	
I_{IH}	Input High Current	$V_{IN} = V_{CC}$ or $2.4V$			± 1	± 10	μA	
I_{IL}	Input Low Current	$V_{IN} = \text{GND}$ or $0.4V$			± 1	± 10	μA	
V_{CL}	Input Diode Clamp Voltage	$I_{CLAMP} = -18\text{ mA}$		-1.5	-0.8		V	
I_{CCD}	Power Supply Current	$DE = \overline{RE} = V_{CC}$, $R_L = 27\Omega$	V_{CC}		13	20	mA	
I_{CCR}		$DE = \overline{RE} = 0V$			5	8	mA	
I_{CCZ}		$DE = 0V$, $\overline{RE} = V_{CC}$			3	7.5	mA	
I_{CC}		$DE = V_{CC}$, $\overline{RE} = 0V$, $R_L = 27\Omega$			16	22	mA	

DC Electrical Characteristics (Notes 2, 3) (Continued)

$T_A = -40^\circ\text{C}$ to $+85^\circ\text{C}$ unless otherwise noted, $V_{CC} = 3.3\text{V} \pm 0.5\text{V}$

Symbol	Parameter	Conditions	Pin	Min	Typ	Max	Units
C_{output}	Capacitance @ BUS Pins		DO+/RI+, DO-/RI-		5		pF

DC Electrical Characteristics (Notes 2, 3)

$T_A = -40^\circ\text{C}$ to $+85^\circ\text{C}$ unless otherwise noted, $V_{CC} = 5.0\text{V} \pm 0.5\text{V}$

Symbol	Parameter	Conditions	Pin	Min	Typ	Max	Units	
V_{OD}	Output Differential Voltage	$R_L = 27\Omega$, Figure 1	DO+/RI+, DO-/RI-	145	270	390	mV	
ΔV_{OD}	V_{OD} Magnitude Change				3	30	mV	
V_{OS}	Offset Voltage			1	1.35	1.65	V	
ΔV_{OS}	Offset Magnitude Change				5	50	mV	
I_{OSD}	Output Short Circuit Current	$V_O = 0\text{V}$, $DE = V_{CC}$			-12	-20	mA	
V_{OH}	Voltage Output High	$V_{\text{ID}} = +100\text{mV}$	$I_{\text{OH}} = -400\mu\text{A}$	R_{OUT}	4.3	5.0		V
		Inputs Open			4.3	5.0		V
		Inputs Shorted			4.3	5.0		V
		Inputs Terminated, $R_L = 27\Omega$			4.3	5.0		V
V_{OL}	Voltage Output Low	$I_{\text{OL}} = 2.0\text{mA}$, $V_{\text{ID}} = -100\text{mV}$			0.1	0.4	V	
I_{OS}	Output Short Circuit Current	$V_{\text{OUT}} = 0\text{V}$, $V_{\text{ID}} = +100\text{mV}$		-35	-90	-130	mA	
V_{TH}	Input Threshold High	$DE = 0\text{V}$	DO+/RI+, DO-/RI-			+100	mV	
V_{TL}	Input Threshold Low			-100			mV	
I_{IN}	Input Current	$DE = 0\text{V}$, $V_{\text{IN}} = +2.4\text{V}$, or 0V		-20	± 1	+20	μA	
		$V_{CC} = 0\text{V}$, $V_{\text{IN}} = +2.4\text{V}$, or 0V		-20	± 1	+20	μA	
V_{IH}	Minimum Input High Voltage		DIN, DE, $\overline{\text{RE}}$	2.0		V_{CC}	V	
V_{IL}	Maximum Input Low Voltage			GND		0.8	V	
I_{IH}	Input High Current	$V_{\text{IN}} = V_{CC}$ or 2.4V			± 1	± 10	μA	
I_{IL}	Input Low Current	$V_{\text{IN}} = \text{GND}$ or 0.4V			± 1	± 10	μA	
V_{CL}	Input Diode Clamp Voltage	$I_{\text{CLAMP}} = -18\text{mA}$		-1.5	-0.8		V	
I_{CCD}	Power Supply Current	$DE = \overline{\text{RE}} = V_{CC}$, $R_L = 27\Omega$	V_{CC}		17	25	mA	
I_{CCR}		$DE = \overline{\text{RE}} = 0\text{V}$			6	10	mA	
I_{CCZ}		$DE = 0\text{V}$, $\overline{\text{RE}} = V_{CC}$			3	8	mA	
I_{CC}		$DE = V_{CC}$, $\overline{\text{RE}} = 0\text{V}$, $R_L = 27\Omega$			20	25	mA	
C_{output}	Capacitance @ BUS Pins		DO+/RI+, DO-/RI-		5		pF	

Note 1: "Absolute Maximum Ratings" are those beyond which the safety of the device cannot be guaranteed. They are not meant to imply that the device should be operated at these limits. The table of "Electrical Characteristics" provides conditions for actual device operation.

Note 2: All currents into device pins are positive; all currents out of device pins are negative. All voltages are referenced to device ground except V_{OD} , V_{ID} , V_{TH} and V_{TL} unless otherwise specified.

Note 3: All typicals are given for $V_{CC} = +3.3\text{V}$ or 5.0V and $T_A = +25^\circ\text{C}$, unless otherwise stated.

Note 4: ESD Rating: HBM (1.5 k Ω , 100 pF) > 2.0 kV EAT (0 Ω , 200 pF) > 300V.

Note 5: C_L includes probe and fixture capacitance.

Note 6: Generator waveforms for all tests unless otherwise specified: $f = 1\text{MHz}$, $Z_O = 50\Omega$, t_r , $t_f \leq 6.0\text{ns}$ (0%–100%) on control pins and $\leq 1.0\text{ns}$ for RI inputs.

Note 7: The DS92LV010A is a current mode device and only function with datasheet specification when a resistive load is applied between the driver outputs.

Note 8: For receiver TRI-STATE[®] delays, the switch is set to V_{CC} for t_{PZL} and t_{PLZ} and to GND for t_{PZH} and t_{PHZ} .

AC Electrical Characteristics (Note 6)

$T_A = -40^{\circ}\text{C}$ to $+85^{\circ}\text{C}$, $V_{CC} = 3.3\text{V} \pm 0.3\text{V}$

Symbol	Parameter	Conditions	Min	Typ	Max	Units	
DIFFERENTIAL DRIVER TIMING REQUIREMENTS							
t_{PHLD}	Differential Prop. Delay High to Low	$R_L = 27\Omega$, <i>Figures 2, 3</i> $C_L = 10\text{ pF}$	1.0	3.0	5.0	ns	
t_{PLHD}	Differential Prop. Delay Low to High		1.0	2.8	5.0	ns	
t_{SKD}	Differential SKEW $ t_{PHLD} - t_{PLHD} $				0.2	1.0	ns
t_{TLH}	Transition Time Low to High				0.3	2.0	ns
t_{THL}	Transition Time High to Low				0.3	2.0	ns
t_{PHZ}	Disable Time High to Z	$R_L = 27\Omega$, <i>Figures 4, 5</i> $C_L = 10\text{ pF}$	0.5	4.5	9.0	ns	
t_{PLZ}	Disable Time Low to Z		0.5	5.0	10.0	ns	
t_{PZH}	Enable Time Z to High		2.0	5.0	7.0	ns	
t_{PZL}	Enable Time Z to Low		1.0	4.5	9.0	ns	
DIFFERENTIAL RECEIVER TIMING REQUIREMENTS							
t_{PHLD}	Differential Prop. Delay High to Low	<i>Figures 6, 7</i> $C_L = 10\text{ pF}$	2.5	5.0	12.0	ns	
t_{PLHD}	Differential Prop. Delay Low to High		2.5	5.5	10.0	ns	
t_{SKD}	Differential SKEW $ t_{PHLD} - t_{PLHD} $				0.5	2.0	ns
t_r	Rise Time				1.5	4.0	ns
t_f	Fall Time				1.5	4.0	ns
t_{PHZ}	Disable Time High to Z	$R_L = 500\Omega$, <i>Figures 8, 9</i> $C_L = 10\text{ pF}$ (Note 8)	2.0	4.0	6.0	ns	
t_{PLZ}	Disable Time Low to Z		2.0	5.0	7.0	ns	
t_{PZH}	Enable Time Z to High		2.0	7.0	13.0	ns	
t_{PZL}	Enable Time Z to Low		2.0	6.0	10.0	ns	

AC Electrical Characteristics (Note 6)

$T_A = -40^{\circ}\text{C}$ to $+85^{\circ}\text{C}$, $V_{CC} = 5.0\text{V} \pm 0.5\text{V}$

Symbol	Parameter	Conditions	Min	Typ	Max	Units	
DIFFERENTIAL DRIVER TIMING REQUIREMENTS							
t_{PHLD}	Differential Prop. Delay High to Low	$R_L = 27\Omega$, <i>Figures 2, 3</i> $C_L = 10\text{ pF}$	0.5	2.7	4.5	ns	
t_{PLHD}	Differential Prop. Delay Low to High		0.5	2.5	4.5	ns	
t_{SKD}	Differential SKEW $ t_{PHLD} - t_{PLHD} $				0.2	1.0	ns
t_{TLH}	Transition Time Low to High				0.3	2.0	ns
t_{THL}	Transition Time High to Low				0.3	2.0	ns
t_{PHZ}	Disable Time High to Z	$R_L = 27\Omega$, <i>Figures 4, 5</i> $C_L = 10\text{ pF}$	0.5	3.0	7.0	ns	
t_{PLZ}	Disable Time Low to Z		0.5	5.0	10.0	ns	
t_{PZH}	Enable Time Z to High		2.0	4.0	7.0	ns	
t_{PZL}	Enable Time Z to Low		1.0	4.0	9.0	ns	
DIFFERENTIAL RECEIVER TIMING REQUIREMENTS							
t_{PHLD}	Differential Prop. Delay High to Low	<i>Figures 6, 7</i> $C_L = 10\text{ pF}$	2.5	5.0	12.0	ns	
t_{PLHD}	Differential Prop. Delay Low to High		2.5	4.6	10.0	ns	
t_{SKD}	Differential SKEW $ t_{PHLD} - t_{PLHD} $				0.4	2.0	ns
t_r	Rise Time				1.2	2.5	ns
t_f	Fall Time				1.2	2.5	ns

AC Electrical Characteristics (Note 6) (Continued)

$T_A = -40^{\circ}\text{C}$ to $+85^{\circ}\text{C}$, $V_{CC} = 5.0\text{V} \pm 0.5\text{V}$

Symbol	Parameter	Conditions	Min	Typ	Max	Units
DIFFERENTIAL RECEIVER TIMING REQUIREMENTS						
t_{PHZ}	Disable Time High to Z	$R_L = 500\Omega$, <i>Figures 8, 9</i> $C_L = 10\text{ pF}$ (Note 8)	2.0	4.0	6.0	ns
t_{PLZ}	Disable Time Low to Z		2.0	4.0	6.0	ns
t_{PZH}	Enable Time Z to High		2.0	5.0	9.0	ns
t_{PZL}	Enable Time Z to Low		2.0	5.0	7.0	ns

Test Circuits and Timing Waveforms

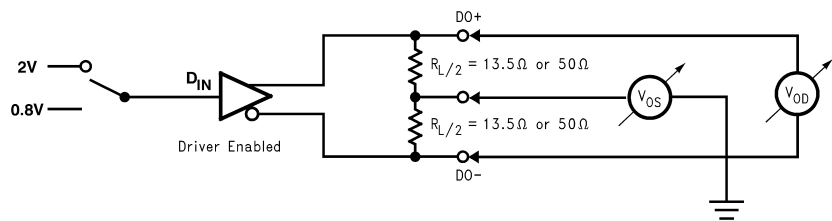

FIGURE 1. Differential Driver DC Test Circuit

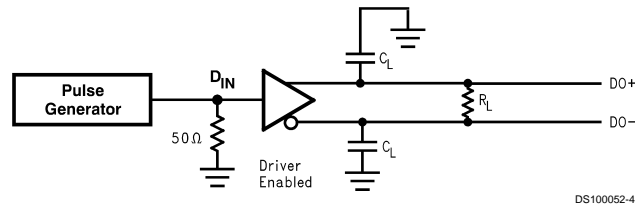

FIGURE 2. Differential Driver Propagation Delay and Transition Time Test Circuit

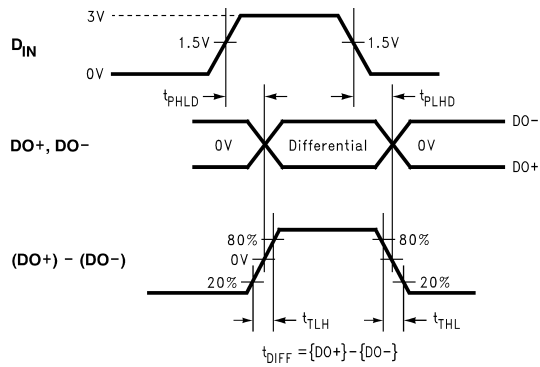
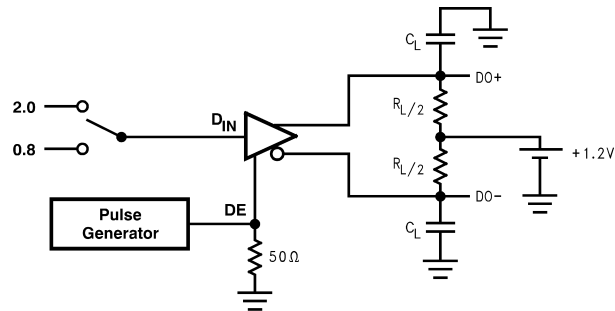

FIGURE 3. Differential Driver Propagation Delay and Transition Time Waveforms

Test Circuits and Timing Waveforms (Continued)



DS100052-6

FIGURE 4. Driver TRI-STATE Delay Test Circuit

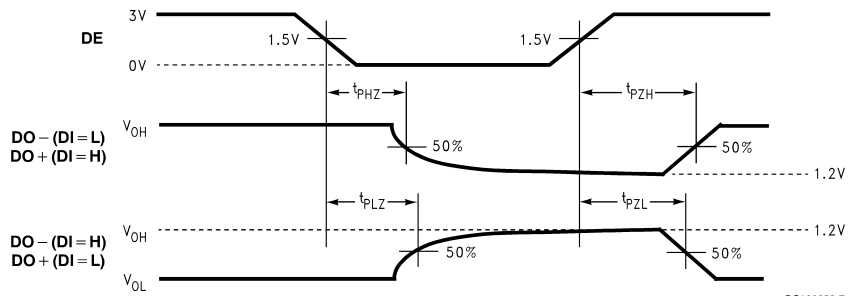

DS100052-7

FIGURE 5. Driver TRI-STATE Delay Waveforms

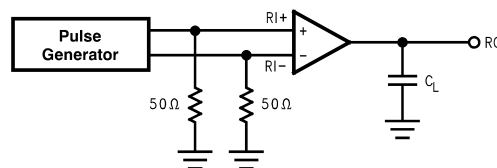

DS100052-8

FIGURE 6. Receiver Propagation Delay and Transition Time Test Circuit

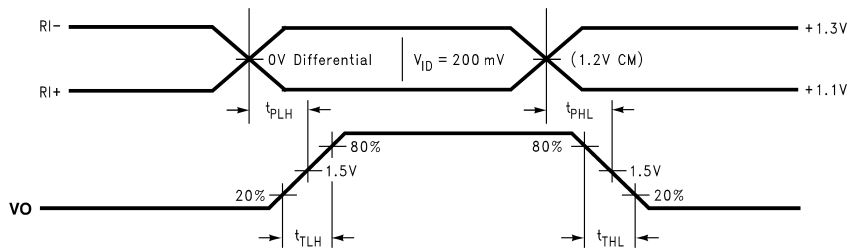

DS100052-9

FIGURE 7. Receiver Propagation Delay and Transition Time Waveforms

Test Circuits and Timing Waveforms (Continued)

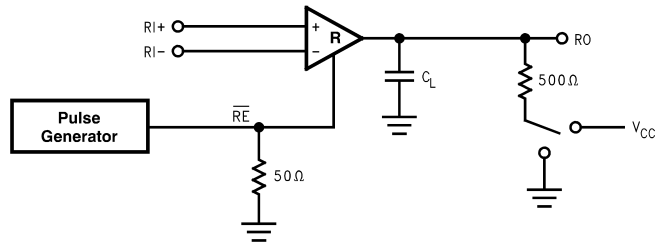

DS100052-10

FIGURE 8. Receiver TRI-STATE Delay Test Circuit

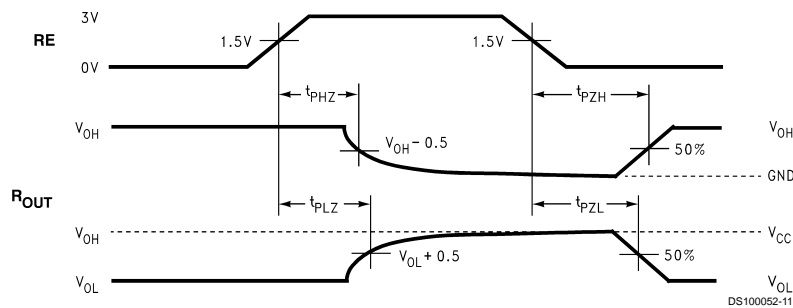

DS100052-11

FIGURE 9. Receiver TRI-STATE Delay Waveforms

Typical Bus Application Configurations

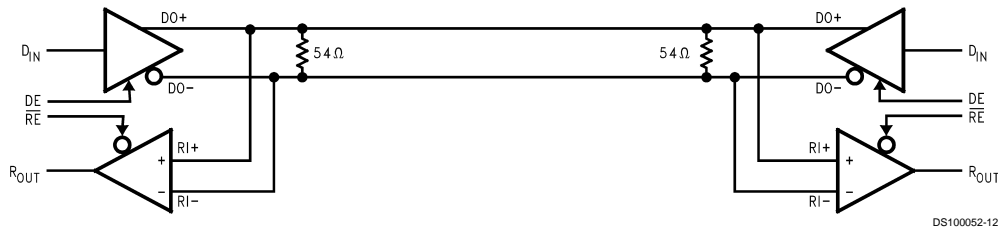

DS100052-12

Bi-Directional Half-Duplex Point-to-Point Applications

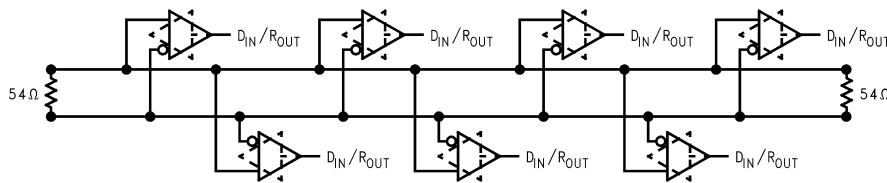

DS100052-13

Multi-Point Bus Applications

Application Information

There are a few common practices which should be implied when designing PCB for BLVDS signaling. Recommended practices are:

- Use at least 4 layer PCB board (BLVDS signals, ground, power and TTL signals).

- Keep drivers and receivers as close to the (BLVDS port side) connector as possible.

Application Information (Continued)

- Bypass each BLVDS device and also use distributed bulk capacitance. Surface mount capacitors placed close to power and ground pins work best. Two or three multi-layer ceramic (MLC) surface mount capacitors (0.1 μ F, and 0.01 μ F in parallel should be used between each V_{CC} and ground. The capacitors should be as close as possible to the V_{CC} pin.

- Use the termination resistor which best matches the differential impedance of your transmission line.
- Leave unused LVDS receiver inputs open (floating)

TABLE 1. Functional Table

MODE SELECTED	DE	\overline{RE}
DRIVER MODE	H	H
RECEIVER MODE	L	L
TRI-STATE MODE	L	H
LOOP BACK MODE	H	L

TABLE 2. Transmitter Mode

INPUTS		OUTPUTS	
DE	DI	DO+	DO-
H	L	L	H
H	H	H	L
H	$2 > \& > 0.8$	X	X
L	X	Z	Z

L = Low state
H = High state

TABLE 3. Receiver Mode

INPUTS		OUTPUT
\overline{RE}	(RI+)-(RI-)	
L	L (< -100 mV)	L
L	H (> +100 mV)	H
L	100 mV > & > -100 mV	X
H	X	Z

X = High or Low logic state
Z = High impedance state
L = Low state
H = High state

TABLE 4. Device Pin Description

Pin Name	Pin #	Input/Output	Description
DIN	2	I	TTL Driver Input
DO \pm /RI \pm	6, 7	I/O	LVDS Driver Outputs/LVDS Receiver Inputs
R _{OUT}	3	O	TTL Receiver Output
\overline{RE}	5	I	Receiver Enable TTL Input (Active Low)
DE	1	I	Driver Enable TTL Input (Active High)
GND	4	NA	Ground
V _{CC}	8	NA	Power Supply



DS92LV010A Bus LVDS 3.3/5.0V Single Transceiver

Physical Dimensions inches (millimeters) unless otherwise noted

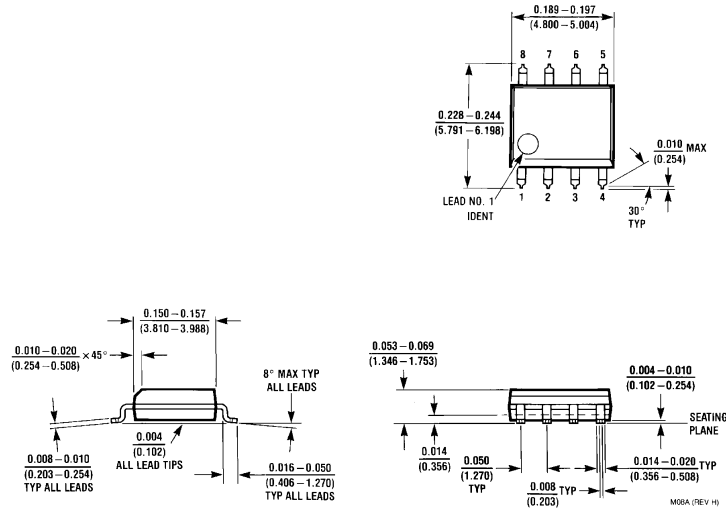

Order Number DS92LV010ATM
See NS Package Number M08A

LIFE SUPPORT POLICY

NATIONAL'S PRODUCTS ARE NOT AUTHORIZED FOR USE AS CRITICAL COMPONENTS IN LIFE SUPPORT DEVICES OR SYSTEMS WITHOUT THE EXPRESS WRITTEN APPROVAL OF THE PRESIDENT OF NATIONAL SEMICONDUCTOR CORPORATION. As used herein:

1. Life support devices or systems are devices or systems which, (a) are intended for surgical implant into the body, or (b) support or sustain life, and whose failure to perform when properly used in accordance with instructions for use provided in the labeling, can be reasonably expected to result in a significant injury to the user.
2. A critical component in any component of a life support device or system whose failure to perform can be reasonably expected to cause the failure of the life support device or system, or to affect its safety or effectiveness.



National Semiconductor Corporation
 Americas
 Tel: 1-800-272-9959
 Fax: 1-800-737-7018
 Email: support@nsc.com

National Semiconductor Europe
 Fax: +49 (0) 1 80-530 85 86
 Email: europe.support@nsc.com
 Deutsch Tel: +49 (0) 1 80-530 85 85
 English Tel: +49 (0) 1 80-532 78 32
 Français Tel: +49 (0) 1 80-532 93 58
 Italiano Tel: +49 (0) 1 80-534 16 80

National Semiconductor Asia Pacific Customer Response Group
 Tel: 65-2544466
 Fax: 65-2504466
 Email: sea.support@nsc.com

National Semiconductor Japan Ltd.
 Tel: 81-3-5620-6175
 Fax: 81-3-5620-6179

www.national.com

National does not assume any responsibility for use of any circuitry described, no circuit patent licenses are implied and National reserves the right at any time without notice to change said circuitry and specifications.