

KA75XXX

Voltage Detector

Features

- Detecting Against Error Operations At The Power On/off.
- Resetting Function For The Low Voltage Microprocessor.
- Checking Low Battery

Description

The KA75250/KA75270/KA75290/KA75310/KA75330/KA75360/KA75390/KA75420/KA75450 prevents the error of system from supply voltage below normal voltage level at the time the power on and instantaneous power off in systems.

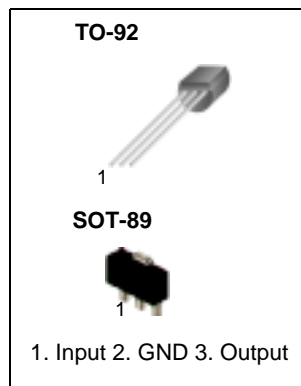

Internal Block Diagram

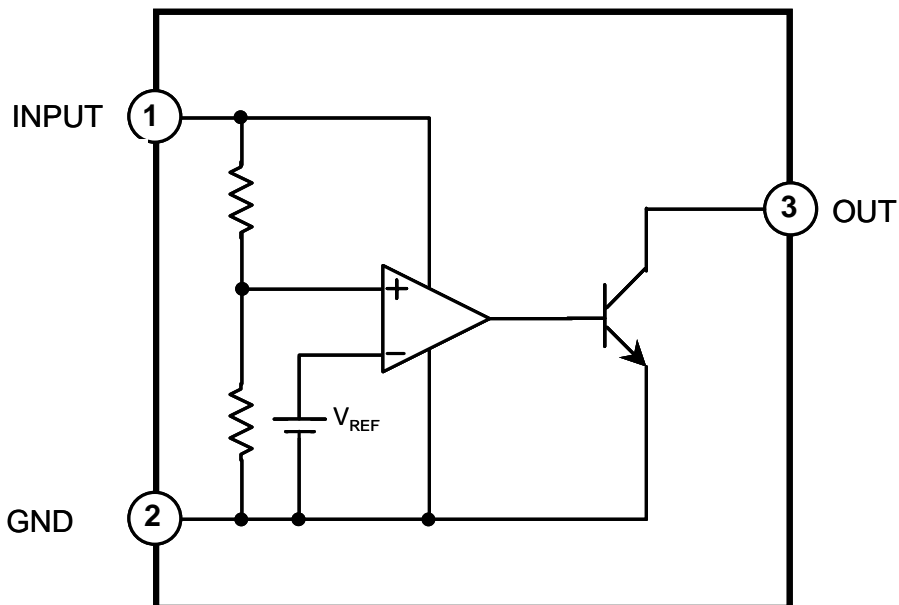

Absolute Maximum Rating (TA=25°C)

Characteristic	Symbol	Value	Unit
Supply Voltage	V _{CC}	0.3 ~ +15.0	V
Detecting Voltage	V _{DET}	2.5/2.7/2.9/3.1 3.3/3.6/3.9/4.2/4.5	V
Hysteresis Voltage	V _{HYS}	50	mV
Operating Temperature	T _{OPR}	-25 ~ +85	°C
Storage Temperature	T _{STG}	-50 ~ +150	°C
Power Dissipation TO-92 SOT-89	P _D	200 500	mW
Detecting Voltage Temperature Coefficient	$\Delta V_{DET}/\Delta T$	R _L = 200Ω, +0.01	%/°C

Electrical Characteristics (TA=25°C)

Characteristic	Symbol	Test Conditions	Min	Typ	Max	Unit	
Detecting Voltage	V _{DET}	R _L = 200Ω	KA75250	2.35	2.5	2.65	V
		V _{OL} ≤ 0.4V	KA75270	2.55	2.7	2.85	
			KA75290	2.75	2.9	3.05	
			KA75310	2.95	3.1	3.25	
			KA75330	3.15	3.3	3.45	
			KA75360	3.45	3.6	3.75	
			KA75390	3.75	3.9	4.05	
			KA75420	4.05	4.2	4.35	
			KA75450	4.35	4.5	4.65	
Low Output Voltage	V _{OL}	R _L = 200Ω	-	-	0.4	V	
Output Leakage Current	I _{LKG}	V _{CC} = 15V	-	-	0.1	μA	
Hysteresis Voltage	V _{HYS}	R _L = 200Ω	30	50	100	mV	
Detecting Voltage Temperature Coefficient	$\Delta V_{DET}/\Delta T$	R _L = 200Ω	-	±0.01	-	%/°C	
Circuit Current(At On Time)	I _{CCL}	V _{CC} = V _{DET(MIN)} - 0.05V	-	300	500	μA	
Circuit Current(At Off Time)	I _{CCH}	V _{CC} = 5.25V	-	30	50	μA	
Threshold Operating Voltage	V _{TH(OPR)}	R _L = 200Ω, V _{OL} ≤ 0.4V	-	0.8	1.0	V	
" L"± Transmission Delay Time	T _{OL}	R _L = 1.0kΩ, C _L = 100pF	0.6	10	-	μs	
" H"± Transmission Delay Time	T _{OH}	R _L = 1.0kΩ, C _L = 100pF	-	15	20	μs	
Output Current (At On Time)	I _{OLI}	V _{CC} = V _{DET(MIN)} - 0.05V, T _A = 25°C	10	20	30	mA	
Output Current (At On Time)	I _{OLII}	V _{CC} = V _{DET(MIN)} - 0.05V T _A = -25 ~ +85°C	8	16	30	mA	

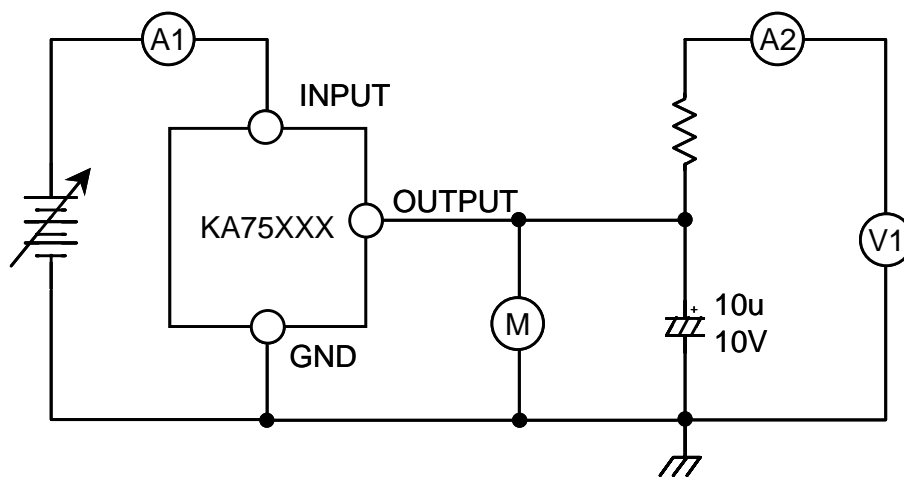
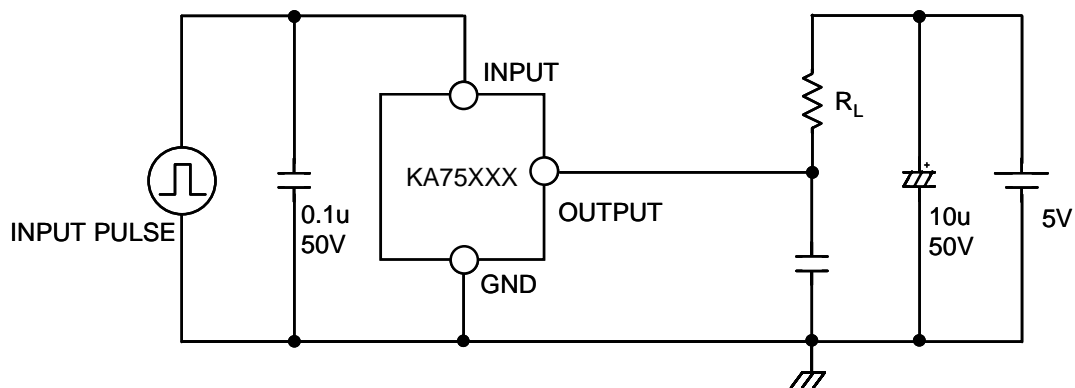
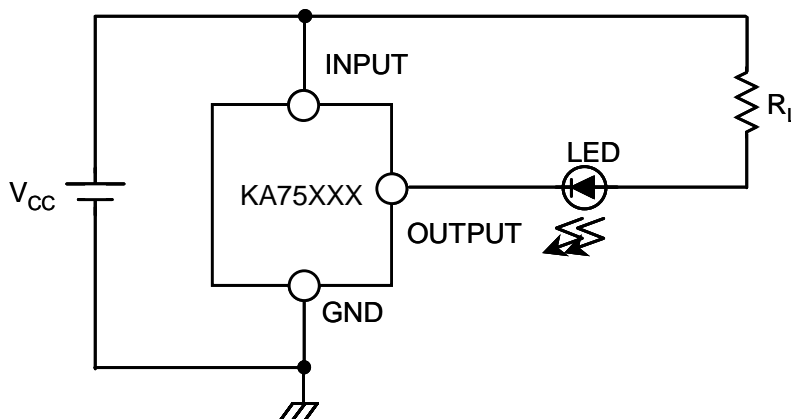
Test Circuit 1.**Test Circuit 2.****Test Circuit 3.**

Application Circuit

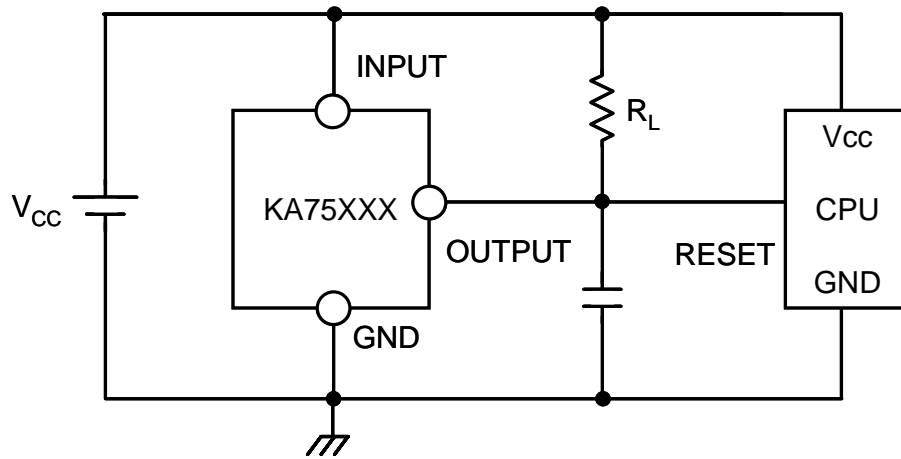

Mechanical Dimensions

Package

Dimensions in millimeters

TO-92

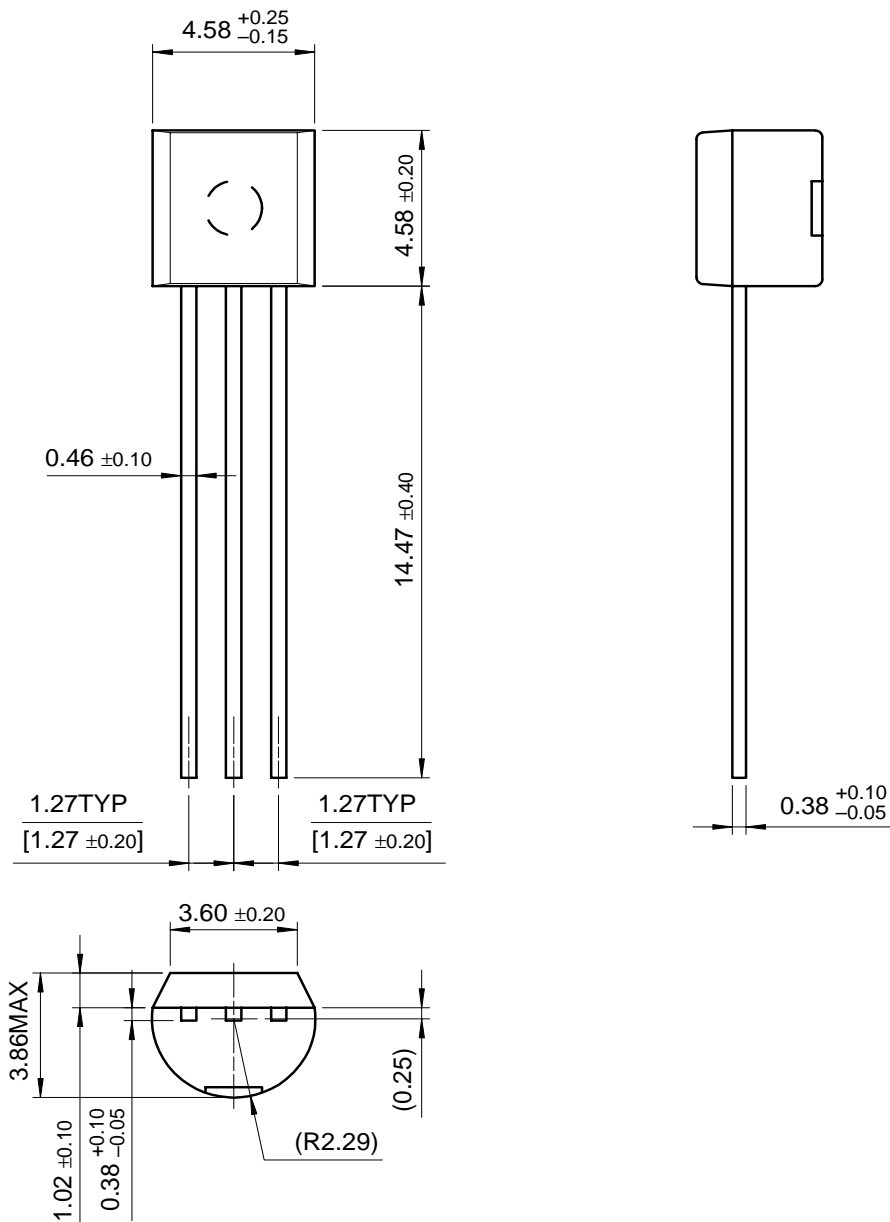

Mechanical Dimensions (Continued)

Package

Dimensions in millimeters

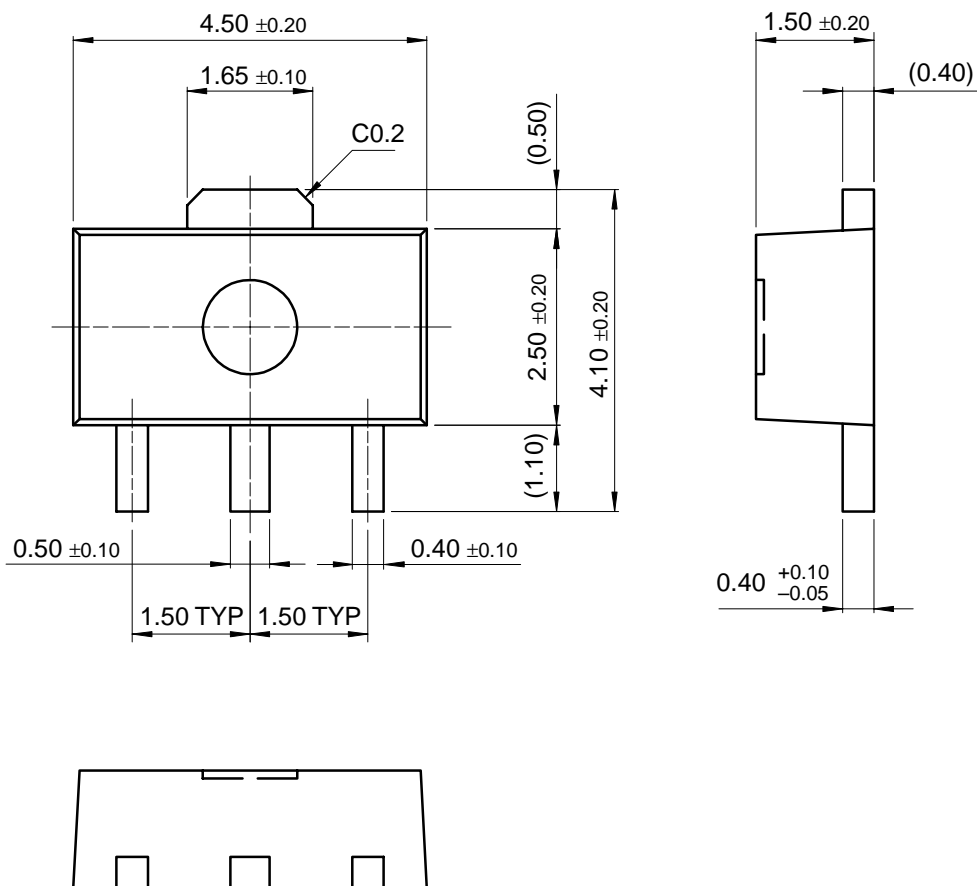
SOT-89

Ordering Information

Product Number	Package	Operating Temperature
KA75250Z	TO-92	-25 ~ +85°C
KA75270Z		
KA75290Z		
KA75310Z		
KA75330Z		
KA75360Z		
KA75390Z		
KA75420Z		
KA75450Z		
KA75250M	SOT-89	
KA75270M		
KA75310M		
KA75330M		
KA75360M		
KA75390M		
KA75420M		
KA75450M		

DISCLAIMER

FAIRCHILD SEMICONDUCTOR RESERVES THE RIGHT TO MAKE CHANGES WITHOUT FURTHER NOTICE TO ANY PRODUCTS HEREIN TO IMPROVE RELIABILITY, FUNCTION OR DESIGN. FAIRCHILD DOES NOT ASSUME ANY LIABILITY ARISING OUT OF THE APPLICATION OR USE OF ANY PRODUCT OR CIRCUIT DESCRIBED HEREIN; NEITHER DOES IT CONVEY ANY LICENSE UNDER ITS PATENT RIGHTS, NOR THE RIGHTS OF OTHERS.

LIFE SUPPORT POLICY

FAIRCHILD'S PRODUCTS ARE NOT AUTHORIZED FOR USE AS CRITICAL COMPONENTS IN LIFE SUPPORT DEVICES OR SYSTEMS WITHOUT THE EXPRESS WRITTEN APPROVAL OF THE PRESIDENT OF FAIRCHILD SEMICONDUCTOR CORPORATION. As used herein:

1. Life support devices or systems are devices or systems which, (a) are intended for surgical implant into the body, or (b) support or sustain life, and (c) whose failure to perform when properly used in accordance with instructions for use provided in the labeling, can be reasonably expected to result in a significant injury of the user.
2. A critical component in any component of a life support device or system whose failure to perform can be reasonably expected to cause the failure of the life support device or system, or to affect its safety or effectiveness.

Mouser Electronics

Authorized Distributor

Click to View Pricing, Inventory, Delivery & Lifecycle Information:

[Fairchild Semiconductor:](#)

[KA75290ZTA](#) [KA75290ZBU](#)