

N-Channel JFETs

J108	SST108
J109	SST109
J110	SST110

PRODUCT SUMMARY				
Part Number	V_{GS(off)} (V)	r_{DS(on)} Max (Ω)	I_{D(off)} Typ (pA)	t_{ON} Typ (ns)
J/SST108	-3 to -10	8	20	4
J/SST109	-2 to -6	12	20	4
J/SST110	-0.5 to -4	18	20	4

FEATURES

- Low On-Resistance: J108 <8 Ω
- Fast Switching—t_{ON}: 4 ns
- Low Leakage: 20 pA
- Low Capacitance: 11 pF
- Low Insertion Loss

BENEFITS

- Low Error Voltage
- High-Speed Analog Circuit Performance
- Negligible “Off-Error” Excellent Accuracy
- Good Frequency Response
- Eliminates Additional Buffering

APPLICATIONS

- Analog Switches
- Choppers
- Sample-and-Hold
- Normally “On” Switches
- Current Limiters

DESCRIPTION

The J/SST108 series is designed with high-performance analog switching applications in mind. It features low on-resistance, good off-isolation, and fast switching.

The SST108 series is comprised of surface-mount devices featuring the lowest r_{DS(on)} of any TO-236 (SOT-23) JFET device.

The TO-226AA (TO-92) plastic package provides a low-cost option. Both the J and SST series are available in tape-and-reel for automated assembly (see Packaging Information). For similar products packaged in TO-206AC (TO-52), see the 2N5432/5433/5434 data sheet.

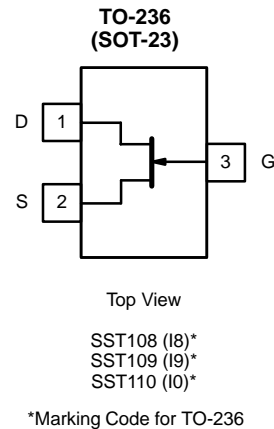
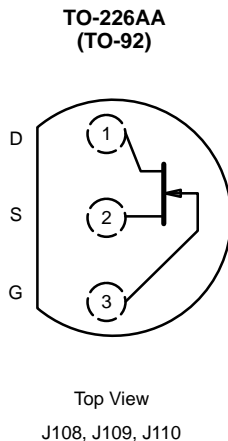



ABSOLUTE MAXIMUM RATINGS

Gate-Drain, Gate-Source Voltage -25 V
 Gate Current 50 mA
 Lead Temperature ($1/16''$ from case for 10 sec.) 300°C
 Storage Temperature -55 to 150°C

Operating Junction Temperature -55 to 150°C
 Power Dissipation^a 350 mW

Notes

a. Derate 2.8 mW/°C above 25°C

SPECIFICATIONS ($T_A = 25^\circ\text{C}$ UNLESS OTHERWISE NOTED)										
Parameter	Symbol	Test Conditions	Typ ^a	Limits						Unit
				J/SST108		J/SST109		J/SST110		
				Min	Max	Min	Max	Min	Max	
Static										
Gate-Source Breakdown Voltage	$V_{(BR)GSS}$	$I_G = -1 \mu\text{A}, V_{DS} = 0 \text{ V}$	-32	-25		-25		-25		V
Gate-Source Cutoff Voltage	$V_{GS(off)}$	$V_{DS} = 5 \text{ V}, I_D = 1 \mu\text{A}$		-3	-10	-2	-6	-0.5	-4	
Saturation Drain Current ^b	I_{DSS}	$V_{DS} = 15 \text{ V}, V_{GS} = 0 \text{ V}$		80		40		10		mA
Gate Reverse Current	I_{GSS}	$V_{GS} = -15 \text{ V}, V_{DS} = 0 \text{ V}$	-0.01		-3		-3		-3	nA
Gate Operating Current	I_G	$V_{DG} = 10 \text{ V}, I_D = 10 \text{ mA}$	-0.01							
Drain Cutoff Current	$I_{D(off)}$	$V_{DS} = 5 \text{ V}, V_{GS} = -10 \text{ V}$	0.02		3		3		3	
Drain-Source On-Resistance	$r_{DS(on)}$	$V_{GS} = 0 \text{ V}, V_{DS} \leq 0.1 \text{ V}$			8		12		18	Ω
Gate-Source Forward Voltage	$V_{GS(F)}$	$I_G = 1 \text{ mA}, V_{DS} = 0 \text{ V}$	0.7							V
Dynamic										
Common-Source Forward Transconductance	g_{fs}	$V_{DS} = 5 \text{ V}, I_D = 10 \text{ mA}, f = 1 \text{ kHz}$	17							mS
Common-Source Output Conductance	g_{os}		0.6							
Drain-Source On-Resistance	$r_{ds(on)}$	$V_{GS} = 0 \text{ V}, I_D = 0 \text{ mA}, f = 1 \text{ kHz}$			8		12		18	Ω
Common-Source Input Capacitance	C_{iss}	$V_{DS} = 0 \text{ V}$ $V_{GS} = 0 \text{ V}$ $f = 1 \text{ MHz}$	SST	60						pF
			J Series	60		85		85		
Common-Source Reverse Transfer Capacitance	C_{rss}	$V_{DS} = 0 \text{ V}$ $V_{GS} = -10 \text{ V}$ $f = 1 \text{ MHz}$	SST	11						
			J Series	11		15		15		
Equivalent Input Noise Voltage	\bar{e}_n	$V_{DG} = 5 \text{ V}, I_D = 10 \text{ mA}$ $f = 1 \text{ kHz}$	3.5							nV/ $\sqrt{\text{Hz}}$
Switching										
Turn-On Time	$t_{d(on)}$	$V_{DD} = 1.5 \text{ V}, V_{GS(H)} = 0 \text{ V}$ See Switching Diagram	3							ns
	t_r		1							
Turn-Off Time	$t_{d(off)}$		4							
	t_f		18							

Notes

a. Typical values are for DESIGN AID ONLY, not guaranteed nor subject to production testing.

b. Pulse test: $PW \leq 300 \mu\text{s}$ duty cycle $\leq 3\%$.

NIP



TYPICAL CHARACTERISTICS (T_A = 25°C UNLESS OTHERWISE NOTED)

On-Resistance and Drain Current vs. Gate-Source Cutoff Voltage

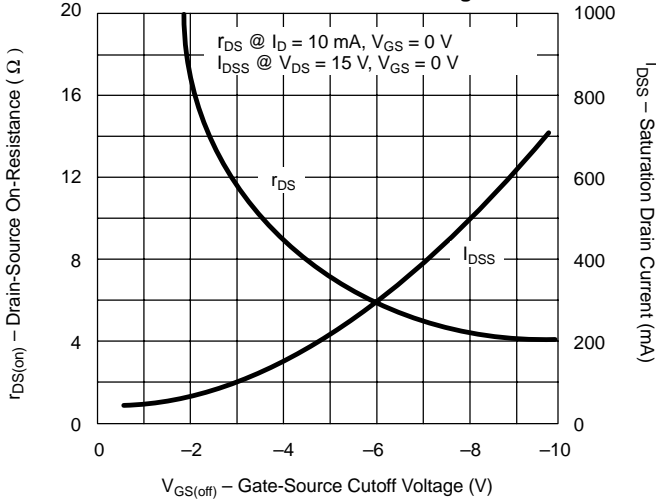

On-Resistance vs. Drain Current

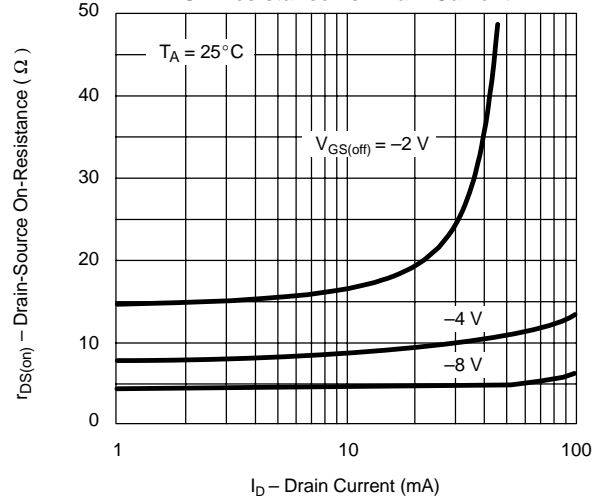

On-Resistance vs. Temperature

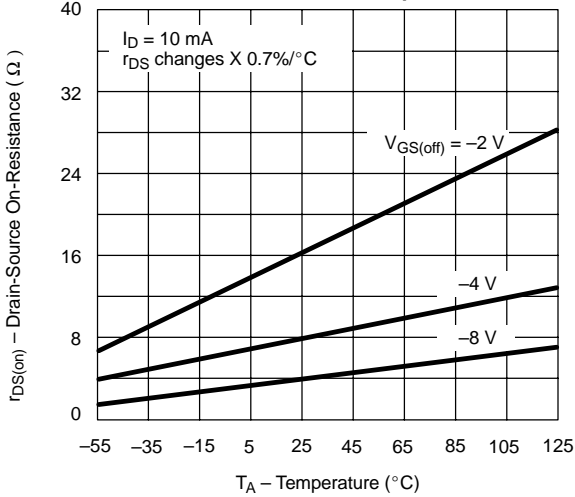

Output Characteristics

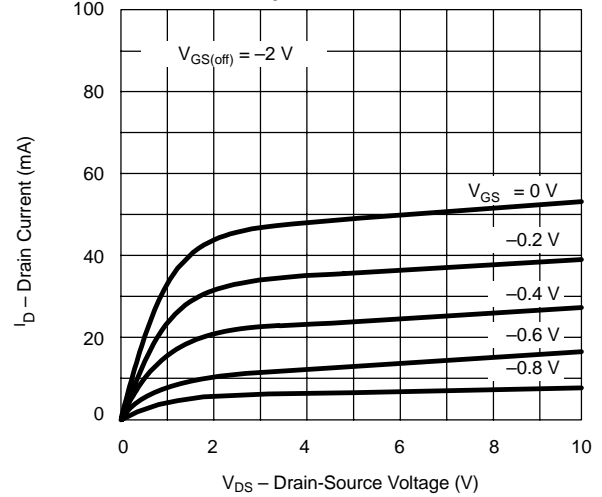

Turn-On Switching

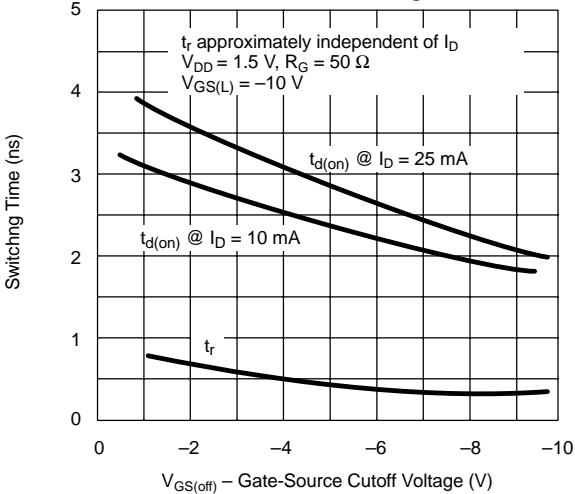

Turn-Off Switching

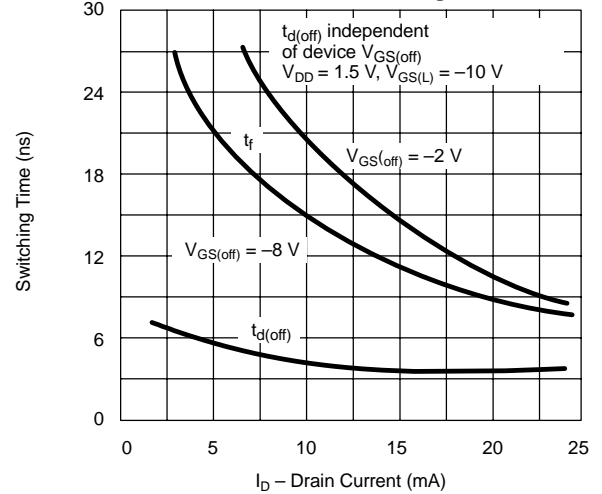



TYPICAL CHARACTERISTICS ($T_A = 25^\circ\text{C}$ UNLESS OTHERWISE NOTED)

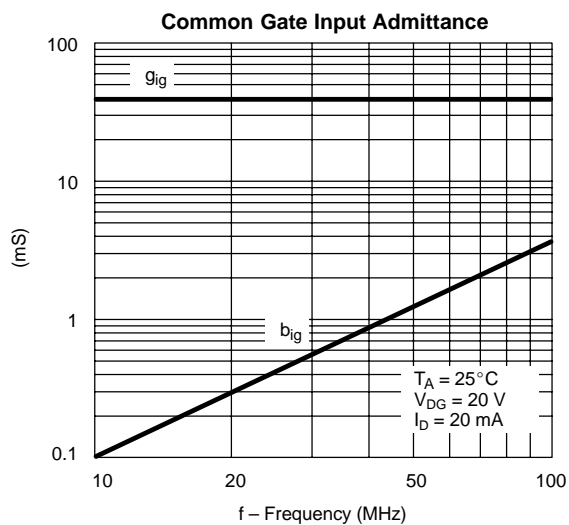
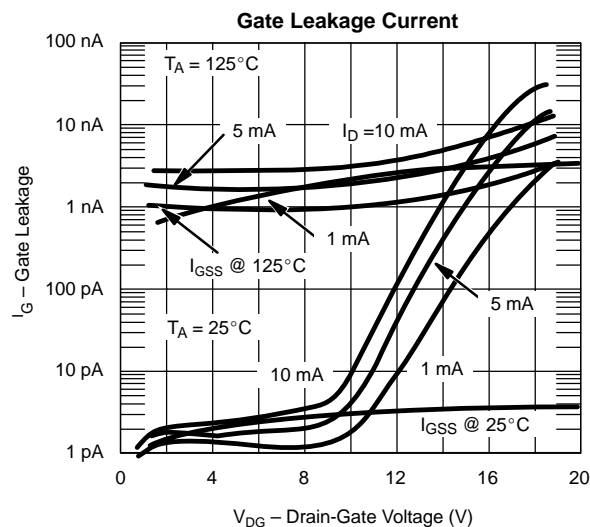
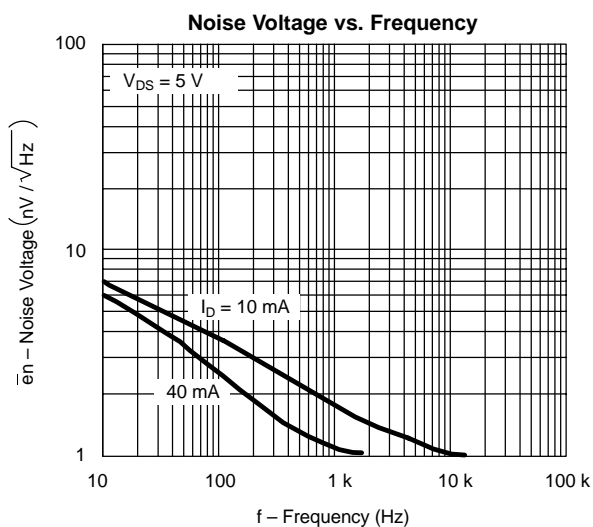
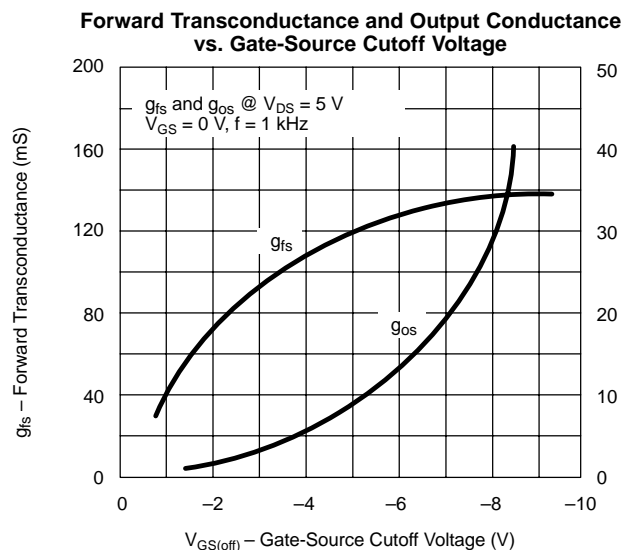
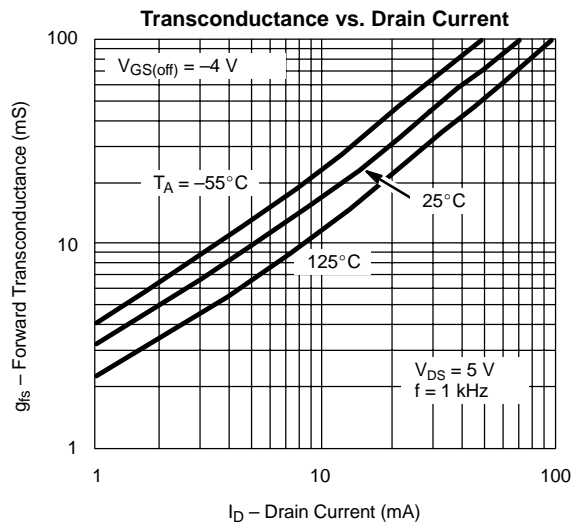
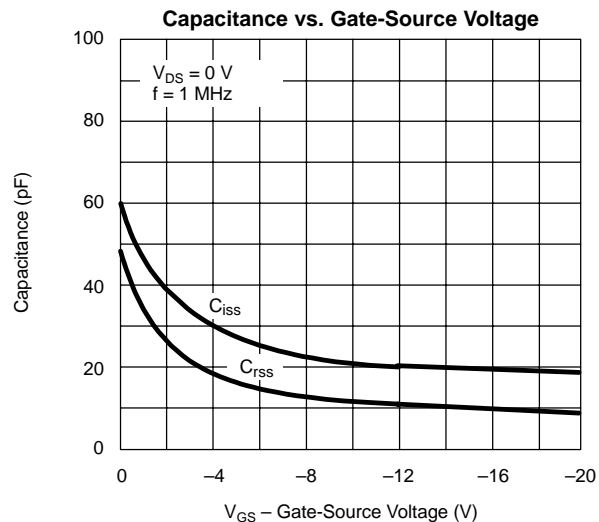



TYPICAL CHARACTERISTICS (T_A = 25°C UNLESS OTHERWISE NOTED)

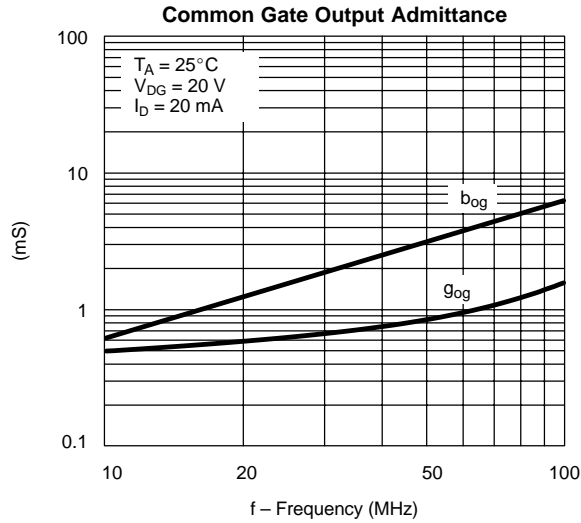
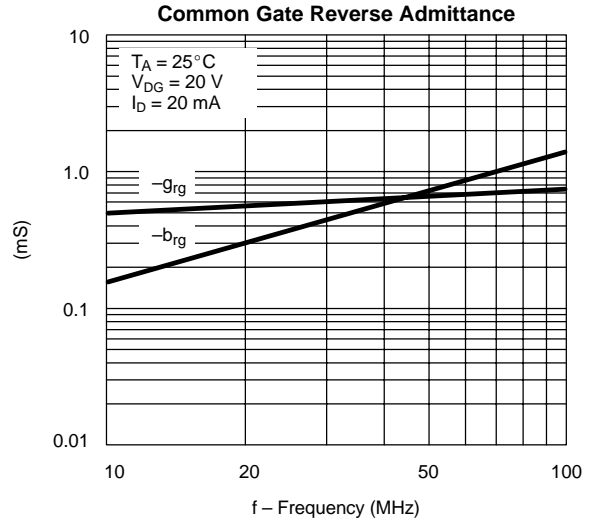
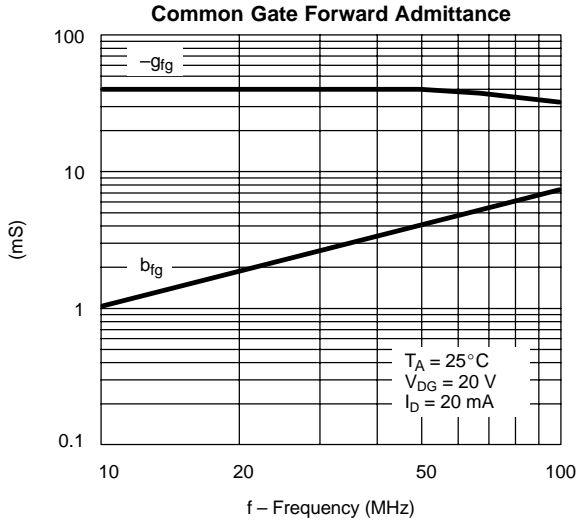

SWITCHING TIME TEST CIRCUIT			
	J/SST108	J/SST109	J/SST110
V _{GS(L)}	-12 V	-7 V	-5 V
R _L *	150 Ω	150 Ω	150 Ω
I _{D(on)}	10 mA	10 mA	10 mA

*Non-inductive

INPUT PULSE

Rise Time < 1 ns
Fall Time < 1 ns
Pulse Width 100 ns
PRF 1 MHz

SAMPLING SCOPE

Rise Time 0.4 ns
Input Resistance 10 MΩ
Input Capacitance 1.5 pF

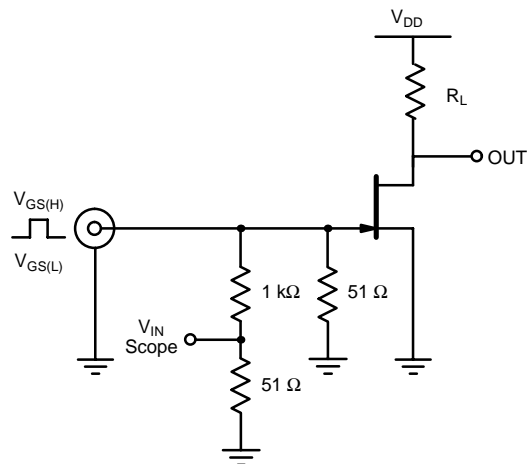

This datasheet has been download from:

www.datasheetcatalog.com

Datasheets for electronics components.