

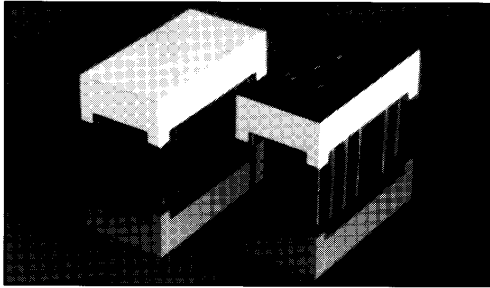

## 0.300-INCH SEVEN SEGMENT DISPLAYS

**HIGH EFFICIENCY GREEN MAN3400A      RED      MAN70A**  
**ORANGE MAN3600A                      YELLOW MAN3800A**



### DESCRIPTION

The MAN3400A, MAN3600A, MAN70A and MAN3800A Series provides a choice of color of LED displays. Standard units are available in Red, Green, Orange and Yellow. They can be mounted in arrays with 0.400-inch (10.16 mm) center-to-center spacing. Yellow and High Efficiency Green displays are constructed with Grey face and neutral segment color. Red displays have Black faces and Red segment color. Others have face and segment color corresponding to the emitted light.

### FEATURES

- Common anode or common cathode models
- Red, Yellow, Green and Orange
- Fast switching — excellent for multiplexing
- Low power consumption
- Bold solid segments that are highly legible
- Solid state reliability — long operation life
- Impact resistant plastic construction
- Directly compatible with integrated circuits
- High brightness with high contrast
- Categorized for Luminous Intensity (See Note 6)
- Standard 14 pin dual-in-line package configuration
- Wide angle viewing ... 150°

### APPLICATIONS

- Digital readout displays
- Instrument panels
- Point of sale equipment
- Calculators
- Digital clocks

### MODEL NUMBERS

PART NUMBER	COLOR	DESCRIPTION
MAN3410A	High Efficiency Green	Common Anode; Right Hand Decimal
MAN3420A	High Efficiency Green	Common Anode; Left Hand Decimal
MAN3440A	High Efficiency Green	Common Cathode; Right Hand Decimal
MAN3610A	Orange	Common Anode; Right Hand Decimal
MAN3620A	Orange	Common Anode; Left Hand Decimal
MAN3630A	Orange	Common Anode; Overflow ±1
MAN3640A	Orange	Common Cathode; Right Hand Decimal
MAN71A	Red	Common Anode; Right Hand Decimal
MAN72A	Red	Common Anode; Left Hand Decimal
MAN73A	Red	Common Anode; Overflow ±1
MAN74A	Red	Common Cathode; Right Hand Decimal
MAN3810A	Yellow	Common Anode; Right Hand Decimal
MAN3820A	Yellow	Common Anode; Left Hand Decimal
MAN3840A	Yellow	Common Cathode; Right Hand Decimal



## 0.300-INCH SEVEN SEGMENT DISPLAYS

<b>ELECTRO-OPTICAL CHARACTERISTICS</b> (25°C Free Air Temperature Unless Otherwise Specified)					
	MIN.	TYP.	MAX.	UNITS	TEST CONDITIONS
<b>MAN3410A, 3420A, 3440A</b>					
Luminous Intensity, digit average (See Notes 1 and 3)	750 900	3200 4000		$\mu$ cd $\mu$ cd	$I_f = 10$ mA $I_f = 60$ mA peak, 1:6 DF
Peak emission wavelength		562		nm	
Spectral line half width		30		nm	
Forward voltage					
Segment		2.2	3.0	V	$I_f = 20$ mA
Decimal point		2.2	3.0	V	$I_f = 20$ mA
Dynamic resistance					
Segment		12		$\Omega$	$I_f = 20$ mA
Decimal point		12		$\Omega$	$I_f = 20$ mA
Capacitance					
Segment		40		pF	V=0
Decimal point		40		pF	V=0
Reverse current					
Segment			100	$\mu$ A	$V_R = 5.0$ V
Decimal point			100	$\mu$ A	$V_R = 5.0$ V
<b>MAN3610A, 3620A, 3630A, 3640A</b>					
Luminous Intensity, digit average (See Note 1 and 3)	510	1800		$\mu$ cd	$I_f = 10$ mA
Peak emission wavelength		630		nm	
Spectral line half width		40		nm	
Forward voltage					
Segment			2.5	V	$I_f = 20$ mA
Decimal point			2.5	V	$I_f = 20$ mA
Dynamic resistance					
Segment		26		$\Omega$	$I_f = 20$ mA
Decimal point		26		$\Omega$	$I_f = 20$ mA
Capacitance					
Segment		35		pF	V=0
Decimal point		35		pF	V=0
Reverse current					
Segment			100	$\mu$ A	$V_R = 5.0$ V
Decimal point			100	$\mu$ A	$V_R = 5.0$ V



## 0.300-INCH SEVEN SEGMENT DISPLAYS

<b>ELECTRO-OPTICAL CHARACTERISTICS</b> (25°C Free Air Temperature Unless Otherwise Specified) (Cont'd)					
	MIN.	TYP.	MAX.	UNITS	TEST CONDITIONS
<b>MAN71A, 72A, 73A, 74A</b>					
Luminous Intensity, digit average (See Note 1 and 3)	125	350		$\mu$ cd	$I_F = 10$ mA
Peak emission wavelength		660		nm	
Spectral line half width		20		nm	
Forward voltage					
Segment			2.0	V	$I_F = 20$ mA
Decimal point			2.0	V	$I_F = 20$ mA
Dynamic resistance					
Segment		2		$\Omega$	$I_{pk} = 100$ mA
Decimal point		2		$\Omega$	$I_{pk} = 100$ mA
Capacitance					
Segment		35	80	pF	V=0
Decimal point		35	80	pF	V=0
Reverse current					
Segment			100	$\mu$ A	$V_R = 5.0$ V
Decimal point			100	$\mu$ A	$V_R = 5.0$ V
<b>MAN3810A, 3820A, 3840A</b>					
Luminous Intensity, digit average (See Note 1 and 3)	450	1700		$\mu$ cd	$I_F = 10$ mA
Peak emission wavelength		585		nm	
Spectral line half width		40		nm	
Forward voltage					
Segment			3.0	V	$I_F = 20$ mA
Decimal point			3.0	V	$I_F = 20$ mA
Dynamic resistance					
Segment		26		$\Omega$	$I_F = 20$ mA
Decimal point		26		$\Omega$	$I_F = 20$ mA
Capacitance					
Segment		35		pF	V=0
Decimal point		35		pF	V=0
Reverse current					
Segment			100	$\mu$ A	$V_R = 5.0$ V
Decimal point			100	$\mu$ A	$V_R = 5.0$ V



## 0.300-INCH SEVEN SEGMENT DISPLAYS

<b>RECOMMENDED OPTICAL FILTERS</b>					
For optimum ON and OFF contrast, one of the following filters or equivalents should be used over the display:					
DEVICE TYPE	FILTER	DEVICE TYPE	FILTER		
MAN3610A } MAN3620A } MAN3630A } MAN3640A }	Panelgraphic Scarlet 65 Homalite 100-1670	MAN71A } MAN72A } MAN73A } MAN74A }	Panelgraphic Red 60 Homalite 100-1605		
MAN3410A } MAN3420A } MAN3440A }		Panelgraphic Green 48 Homalite 100-1440 Green		MAN3810A } MAN3820A } MAN3840A }	Panelgraphic Yellow 25 or Amber 23 Homalite 100-1720 or 100-1726 Panelgraphic Grey 10 Homalite 100-1266 Grey

<b>ABSOLUTE MAXIMUM RATINGS</b>			
	HIGH EFF. GREEN	RED	
	MAN3410A MAN3420A MAN3440A	MAN71A MAN72A MAN74A	MAN73A
Power dissipation at 25°C ambient	600 mW	480 mW	300 mW
Derate linearly from 50°C	-12 mW/°C	-6.9 mW/°C	-4.29 mW/°C
Storage and operating temperature	-40°C to +85°C	-40°C to +85°C	-40°C to +85°C
Continuous forward current			
Total	240 mA	240 mA	150 mA
Per segment	30 mA	30 mA	30 mA
Decimal point	30 mA	30 mA	30 mA
Reverse voltage			
Per segment	6.0 V	6.0 V	6.0 V
Decimal point	6.0 V	6.0 V	6.0 V
Soldering time at 260°C (See Notes 4 and 5)	5 sec.	5 sec.	5 sec.
	YELLOW	ORANGE	
	MAN3810A MAN3820A MAN3840A	MAN3610A MAN3620A MAN3640A	MAN3630A
Power dissipation at 25°C ambient	600 mW	600 mW	375 mW
Derate linearly from 50°C	-10.3 mW/°C	-8.6 mW/°C	-5.36 mW/°C
Storage and operating temperature	-40°C to +85°C	-40°C to +85°C	-40°C to +85°C
Continuous forward current			
Total	200 mA	240 mA	150 mA
Per segment	25 mA	30 mA	30 mA
Decimal point	25 mA	30 mA	30 mA
Reverse voltage			
Per segment	6.0 V	6.0 V	6.0 V
Decimal point	6.0 V	6.0 V	6.0 V
Soldering time at 260°C (See Notes 4 and 5)	5 sec.	5 sec.	5 sec.

<b>TYPICAL THERMAL CHARACTERISTICS</b>	
<b>GREEN/YELLOW</b>	
Thermal resistance junction to free air $\Phi_{JA}$	160°C/W
Wavelength temperature coefficient (case temperature)	1.0Å/°C
Forward voltage temperature coefficient	-1.5 mV/°C
<b>RED/ORANGE</b>	
Thermal resistance junction to free air $\Phi_{JA}$	160°C/W
Wavelength temperature coefficient (case temperature)	1.0Å/°C
Forward voltage temperature coefficient	-2.0 mV/°C

<b>NOTES</b>
1. The digit average Luminous Intensity is obtained by summing the Luminous Intensity of each segment and dividing by the total number of segments. Intensity will not vary more than $\pm 33.3\%$ between all segments within a digit.
2. The curve in Figures 3, 6, 9, and 12 is normalized to the brightness at 25°C to indicate the relative Luminous Intensity over the operating temperature range.
3. The decimal point is designed to have the same surface brightness as the segments, therefore, the Luminous Intensity of the decimal point is .3 times the Luminous Intensity of the segments, since the area of the decimal point is .3 times the area of the average segment.
4. Leads of the device immersed to 1/16 inch from the body. Maximum device surface temperature is 140°C.
5. For flux removal, Freon TF, Freon TE, Isoproponal or water may be used up to their boiling points.
6. All displays are categorized for Luminous Intensity. The Intensity category is marked on each part as a suffix letter to the part number.

**PACKAGE DIMENSIONS**

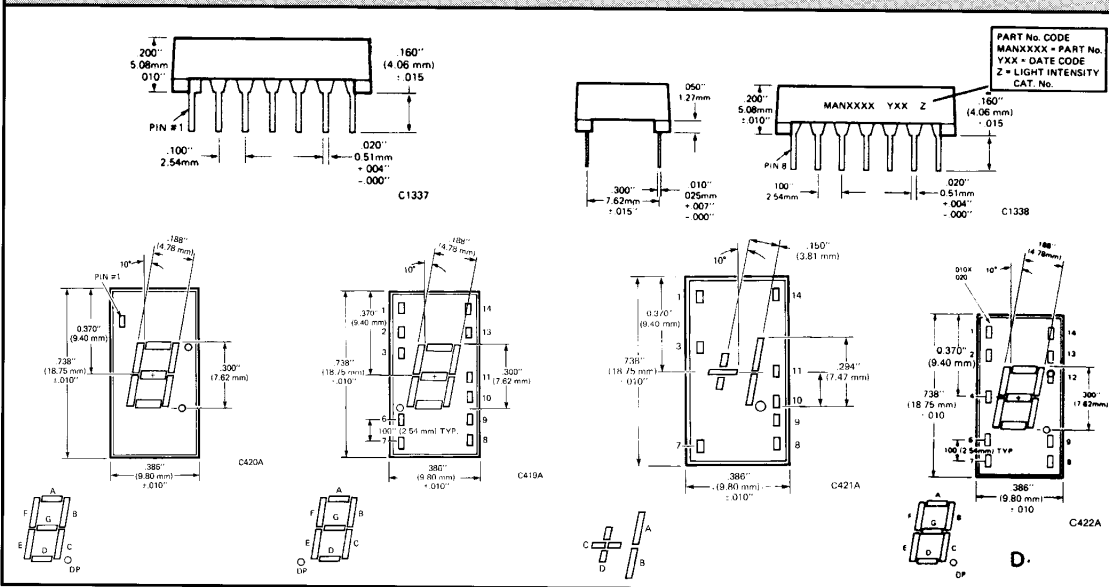

**ELECTRICAL CONNECTIONS**

Pin No.	ELECTRICAL CONNECTIONS			
	A MAN3410A, 3610A, 71A, 3810A	B MAN3420A, 72A, 3620A, 3820A	C MAN3630A, 73A	D MAN3440A, 3640A, 74A, 3840A
1	Cathode A	Cathode A	Anode C, D	Anode F
2	Cathode F	Cathode F	No Pin	Anode G
3	Common Anode	Common Anode	Anode C, D	No Pin
4	No Pin	No Pin	No Pin	Common Cathode
5	No Pin	No Pin	No Pin	No Pin
6	No Connection	Cathode D.P.	No Pin	Anode E
7	Cathode E	Cathode E	Cathode D	Anode D
8	Cathode D	Cathode D	Cathode C	Anode C
9	Cathode D.P.	No Connection	No Connection	Anode D.P.
10	Cathode C	Cathode C	Cathode B	No Pin
11	Cathode G	Cathode G	Cathode A	No Pin
12	No Pin	No Pin	No Pin	Common Cathode
13	Cathode B	Cathode B	No Pin	Anode B
14	Common Anode	Common Anode	Anode A, B	Anode A

**ELECTRICAL SCHEMATIC**

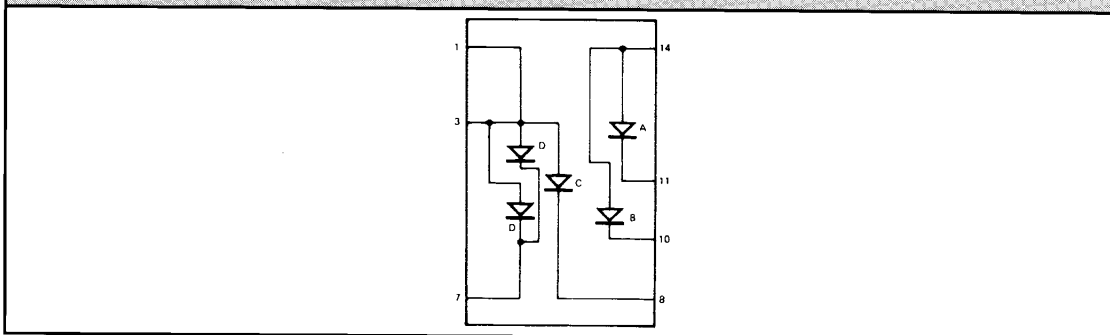

**TYPICAL CHARACTERISTIC CURVES**

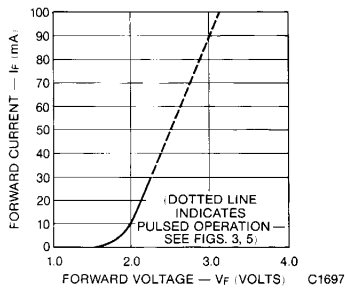

Fig. 1. Forward Current vs. Forward Voltage

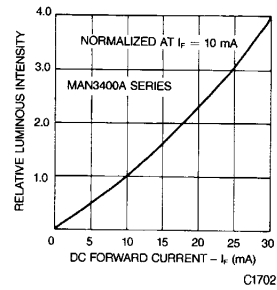

Fig. 2. Relative Luminous Intensity vs. DC Forward Current

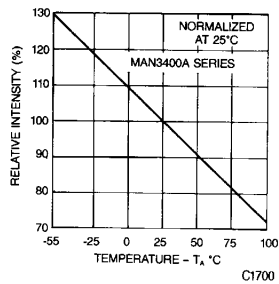

Fig. 3. Relative Luminous Intensity vs. Temperature

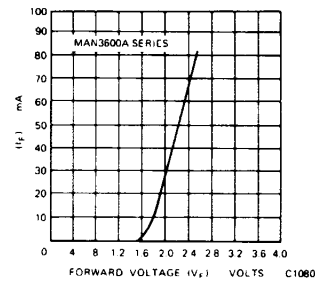

Fig. 4. Forward Current vs. Forward Voltage

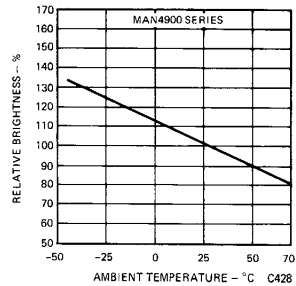

Fig. 5. Relative Luminous Intensity vs. Temperature

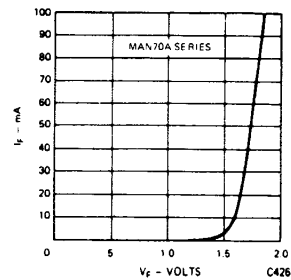

Fig. 6. Forward Current vs. Forward Voltage

**TYPICAL CHARACTERISTIC CURVES (Cont'd)**

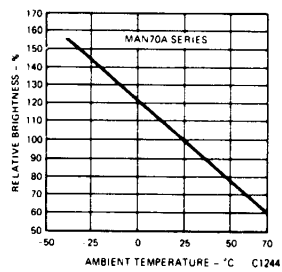

Fig. 7. Relative Luminous Intensity vs. Temperature

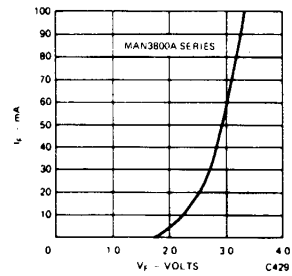

Fig. 8. Forward Current vs. Forward Voltage

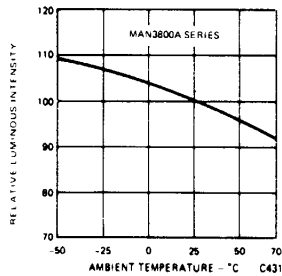

Fig. 9. Relative Luminous Intensity vs. Temperature

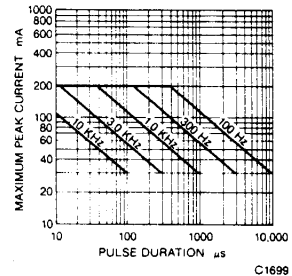

Fig. 10. Maximum Peak Current vs. Pulse Duration

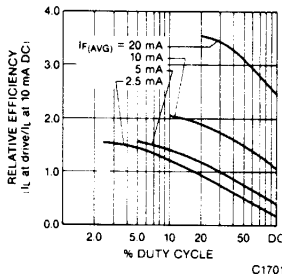

Fig. 11. Relative Efficiency vs. Duty Cycle

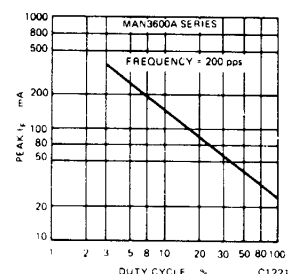

Fig. 12. Max Peak Current vs. Duty Cycle

**TYPICAL CHARACTERISTIC CURVES (Cont'd)**

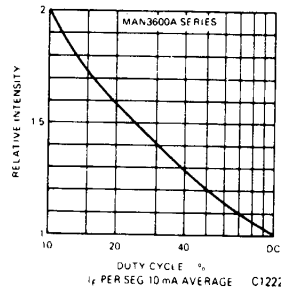

Fig. 13. Luminous Intensity vs. Duty Cycle

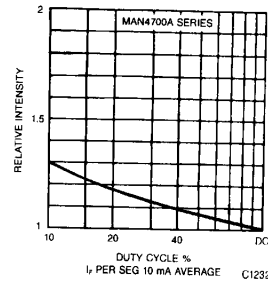

Fig. 14. Luminous Intensity vs. Duty Cycle

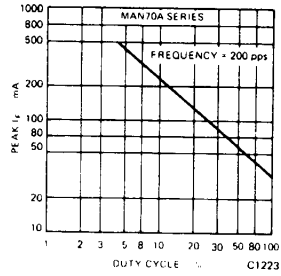

Fig. 15. Max Peak Current vs. Duty Cycle

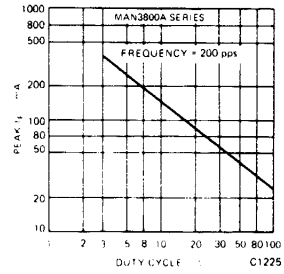

Fig. 16. Max Peak Current vs. Duty Cycle

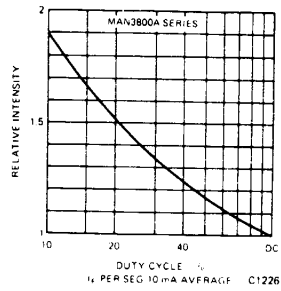

Fig. 17. Luminous Intensity vs. Duty Cycle

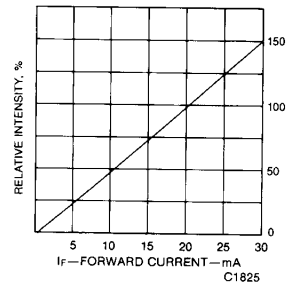

Fig. 18. Relative Luminous Intensity vs. Forward Current



This datasheet has been downloaded from:

[www.DatasheetCatalog.com](http://www.DatasheetCatalog.com)

Datasheets for electronic components.