

Features

- Schottky Barrier Chip
- Guard Ring Die Construction for Transient Protection
- High Current Capability
- Low Power Loss, High Efficiency
- High Surge Current Capability
- For Use in Low Voltage, High Frequency Inverters, Free Wheeling, and Polarity Protection Applications

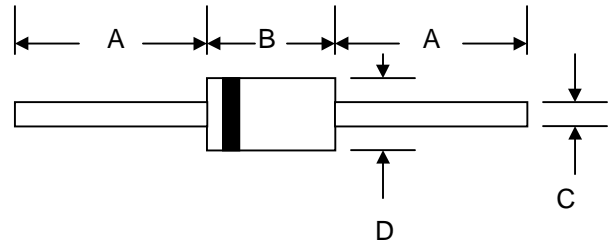

Mechanical Data

- Case: DO-41, Molded Plastic
- Terminals: Plated Leads Solderable per MIL-STD-202, Method 208
- Polarity: Cathode Band
- Weight: 0.34 grams (approx.)
- Mounting Position: Any
- Marking: Type Number
- **Lead Free: For RoHS / Lead Free Version, Add "-LF" Suffix to Part Number, See Page 4**

DO-41		
Dim	Min	Max
A	25.4	—
B	4.06	5.21
C	0.71	0.864
D	2.00	2.72
All Dimensions in mm		

Maximum Ratings and Electrical Characteristics @ $T_A=25^\circ\text{C}$ unless otherwise specified

Single Phase, half wave, 60Hz, resistive or inductive load.
For capacitive load, derate current by 20%.

Characteristic	Symbol	1N5817	1N5818	1N5819	Unit
Peak Repetitive Reverse Voltage	V_{RRM}				V
Working Peak Reverse Voltage	V_{RWM}	20	30	40	
DC Blocking Voltage	V_R				
RMS Reverse Voltage	$V_{R(RMS)}$	14	21	28	V
Average Rectified Output Current (Note 1) @ $T_L = 90^\circ\text{C}$	I_O	1.0			A
Non-Repetitive Peak Forward Surge Current 8.3ms Single half sine-wave superimposed on rated load (JEDEC Method)	I_{FSM}	25			A
Forward Voltage @ $I_F = 1.0\text{A}$ @ $I_F = 3.0\text{A}$	V_{FM}	0.450 0.750	0.550 0.875	0.60 0.90	V
Peak Reverse Current At Rated DC Blocking Voltage @ $T_A = 25^\circ\text{C}$ @ $T_A = 100^\circ\text{C}$	I_{RM}	1.0 10			mA
Typical Junction Capacitance (Note 2)	C_j	110			pF
Typical Thermal Resistance Junction to Lead (Note 1)	$R_{\theta JL}$	15			$^\circ\text{C/W}$
Operating and Storage Temperature Range	T_j, T_{STG}	-65 to +150			$^\circ\text{C}$

Note: 1. Valid provided that leads are kept at ambient temperature at a distance of 9.5mm from the case.
2. Measured at 1.0 MHz and applied reverse voltage of 4.0V D.C.

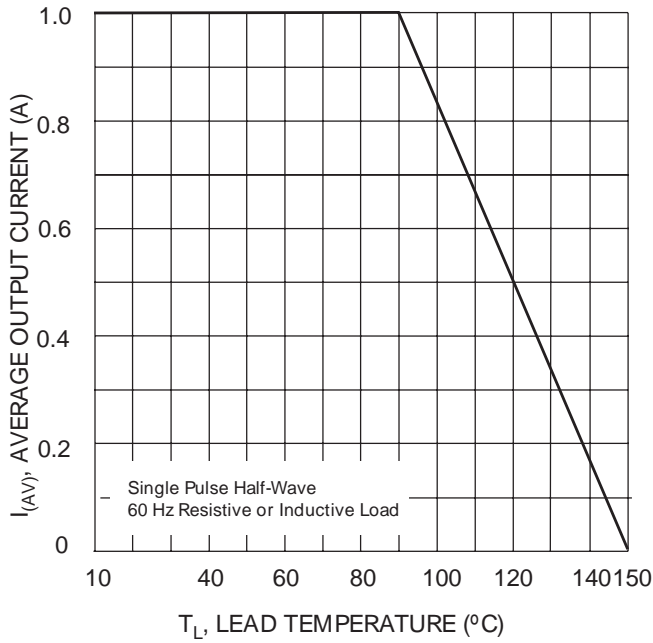

Fig. 1 Forward Current Derating Curve

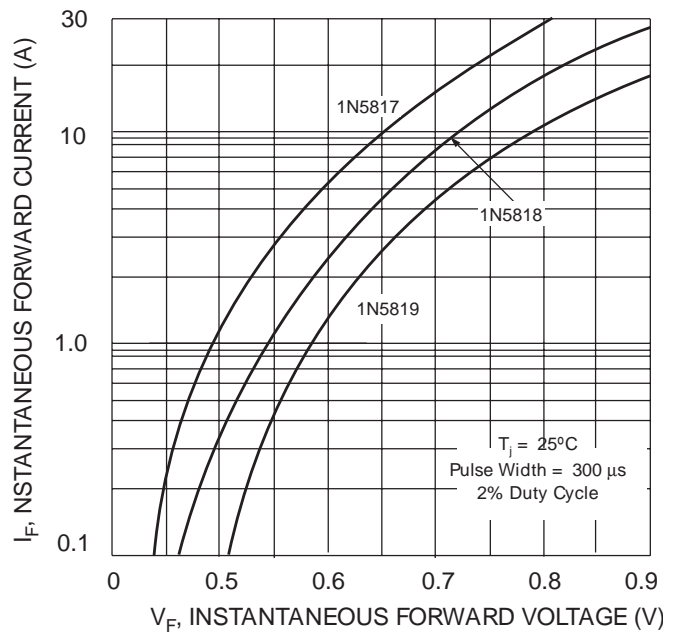

Fig. 2 Typical Forward Characteristics

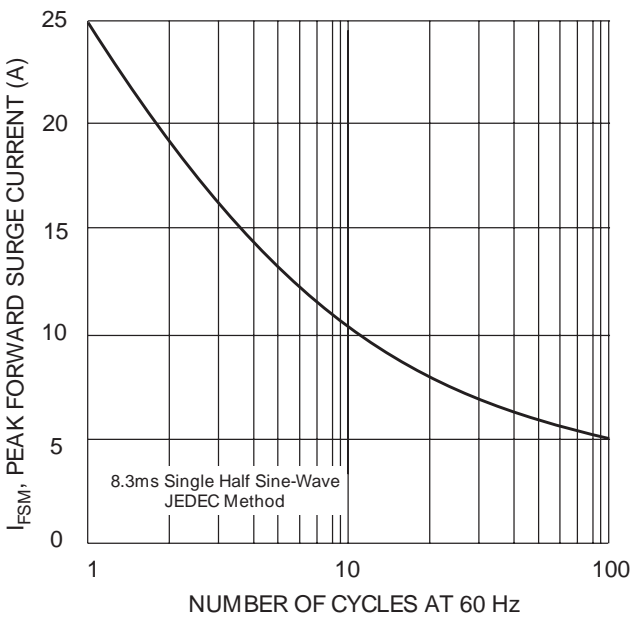

Fig. 3 Maximum Non-Repetitive Peak Fwd Surge Current

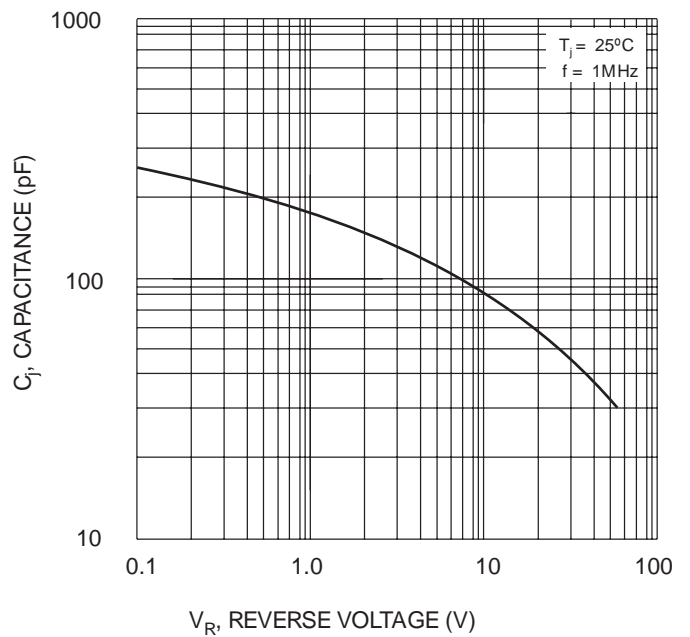
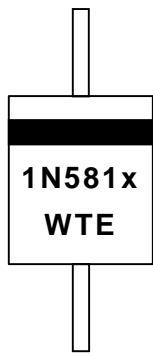

Fig. 4 Typical Junction Capacitance

MARKING INFORMATION



Cathode = Polarity Band
 1N581x = Device Number
 x = 7, 8 or 9
 WTE = Manufacturer's Logo

TAPING SPECIFICATIONS

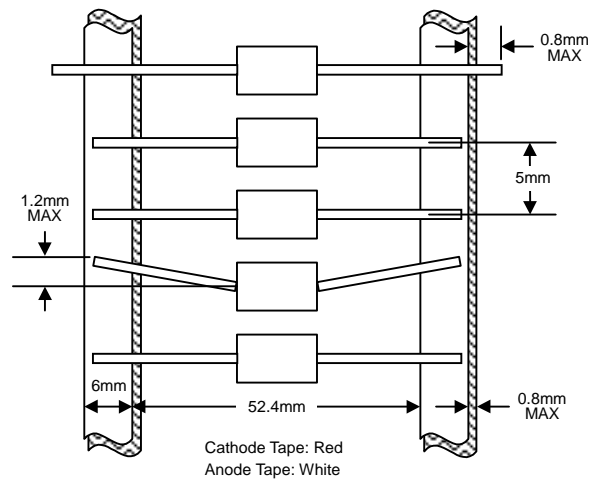

PACKAGING INFORMATION

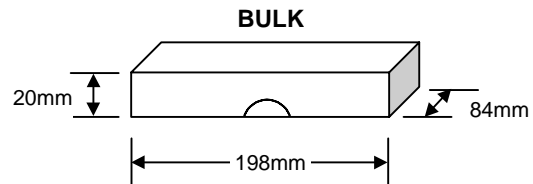
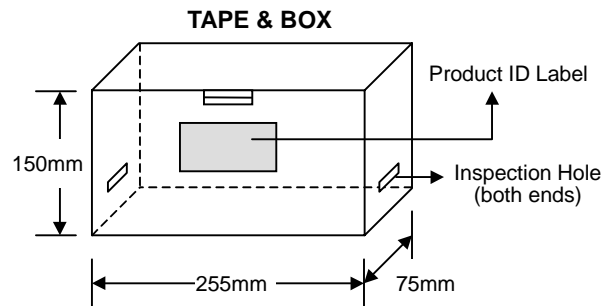

Packaging	Reel Diameter / Box Size (mm)	Quantity (PCS)	Carton Size (mm)	Quantity (PCS)	Approx. Gross Weight (KG)
TAPE & REEL	330	5,000	370 x 370 x 420	25,000	13.0
TAPE & BOX	255 x 75 x 150	5,000	400 x 273 x 415	50,000	21.0
BULK	198 x 84 x 20	1,000	459 x 214 x 256	50,000	19.5

Note: 1. Paper reel, white or gray color. Core material: plastic or metal.
 2. Components are packed in accordance with EIA standard RS-296-E.

ORDERING INFORMATION

Product No.	Package Type	Shipping Quantity
1N5817-T3	DO-41	5000/Tape & Reel
1N5817-TB	DO-41	5000/Tape & Box
1N5817	DO-41	1000 Units/Box
1N5818-T3	DO-41	5000/Tape & Reel
1N5818-TB	DO-41	5000/Tape & Box
1N5818	DO-41	1000 Units/Box
1N5819-T3	DO-41	5000/Tape & Reel
1N5819-TB	DO-41	5000/Tape & Box
1N5819	DO-41	1000 Units/Box

1. Products listed in **bold** are WTE **Preferred** devices.
2. Shipping quantity given is for minimum packing quantity only. For minimum order quantity, please consult the Sales Department.
3. **To order RoHS / Lead Free version (with Lead Free finish), add "-LF" suffix to part number above. For example, 1N5817-TB-LF.**

Won-Top Electronics Co., Ltd (WTE) has checked all information carefully and believes it to be correct and accurate. However, WTE cannot assume any responsibility for inaccuracies. Furthermore, this information does not give the purchaser of semiconductor devices any license under patent rights to manufacturer. WTE reserves the right to change any or all information herein without further notice.

WARNING: DO NOT USE IN LIFE SUPPORT EQUIPMENT. WTE power semiconductor products are not authorized for use as critical components in life support devices or systems without the express written approval.

Won-Top Electronics Co., Ltd.

No. 44 Yu Kang North 3rd Road, Chine Chen Dist., Kaohsiung, Taiwan

Phone: 886-7-822-5408 or 886-7-822-5410

Fax: 886-7-822-5417

Email: sales@wontop.com

Internet: <http://www.wontop.com>

We power your everyday.