

MM74C221 Dual Monostable Multivibrator

General Description

The MM74C221 dual monostable multivibrator is a monolithic complementary MOS integrated circuit. Each multivibrator features a negative-transition-triggered input and a positive-transition-triggered input, either of which can be used as an inhibit input, and a clear input.

Once fired, the output pulses are independent of further transitions of the A and B inputs and are a function of the external timing components C_{EXT} and R_{EXT} . The pulse width is stable over a wide range of temperature and V_{CC} .

Pulse stability will be limited by the accuracy of external timing components. The pulse width is approximately defined by the relationship $t_{W(OUT)} \approx C_{EXT} R_{EXT}$. For further information and applications, see AN-138.

Features

- Wide supply voltage range: 4.5V to 15V
- Guaranteed noise margin: 1.0V
- High noise immunity: $0.45 V_{CC}$ (typ.)
- Low power TTL compatibility: fan out of 2 driving 74L

Ordering Code:

Order Number	Package Number	Package Description
74MMC221N	N16E	16-Lead Plastic Dual-in-Line Package (PDIP), JEDEC MS-001, 0.300" Wide

Connection Diagrams

Timing Component

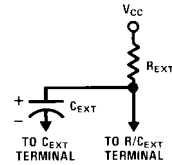

Pin Assignments for DIP

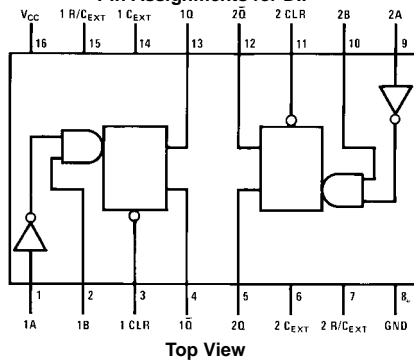

Truth Table

Clear	Inputs		Outputs	
	A	B	Q	\bar{Q}
L	X	X	L	H
X	H	X	L	H
X	X	L	L	H
H	L	↑	⌋	⌋
H	↓	H	⌋	⌋

H = HIGH Level ⌋ = One HIGH level pulse
 L = LOW Level ⌋ = One LOW level pulse
 ↑ = Transition from LOW-to-HIGH X = Irrelevant
 ↓ = Transition from HIGH-to-LOW

Absolute Maximum Ratings (Note 1)		Absolute Maximum V_{CC}	18V
Voltage at Any Pin	-0.3V to $V_{CC} + 0.3V$	$R_{EXT} \geq 80 V_{CC} (\Omega)$	
Operating Temperature Range	-40°C to +85°C	Lead Temperature	
Storage Temperature Range	-65°C to +150°C	(Soldering, 10 seconds)	260°C
Power Dissipation			
Dual-In-Line	700 mW		
Small Outline	500 mW		
Operating V_{CC} Range	4.5V to 15V		

Note 1: "Absolute Maximum Ratings" are those values beyond which the safety of the device cannot be guaranteed. Except for "Operating Temperature Range" they are not meant to imply that the devices should be operated at these limits. The Electrical Characteristics table provides conditions for actual device operation.

DC Electrical Characteristics

Max/min limits apply across temperature range, unless otherwise noted

Symbol	Parameter	Conditions	Min	Typ	Max	Units
CMOS to CMOS						
$V_{IN(1)}$	Logical "1" Input Voltage	$V_{CC} = 5V$ $V_{CC} = 10V$	3.5 8.0			V V
$V_{IN(0)}$	Logical "0" Input Voltage	$V_{CC} = 5V$ $V_{CC} = 10V$			1.5 2.0	V V
$V_{OUT(1)}$	Logical "1" Output Voltage	$V_{CC} = 5V, I_O = -10 \mu A$ $V_{CC} = 10V, I_O = -10 \mu A$	4.5 9.0			V V
$V_{OUT(0)}$	Logical "0" Output Voltage	$V_{CC} = 5V, I_O = +10 \mu A$ $V_{CC} = 10V, I_O = +10 \mu A$			0.5 1	V V
$I_{IN(1)}$	Logical "1" Input Current	$V_{CC} = 15V, V_{IN} = 15V$		0.005	1.0	μA
$I_{IN(0)}$	Logical "0" Input Current	$V_{CC} = 15V, V_{IN} = 0V$	-1.0	-0.005		μA
I_{CC}	Supply Current (Standby)	$V_{CC} = 15V, R_{EXT} = \infty$, Q1, Q2 = Logic "0" (Note 2)		0.05	300	μA
I_{CC}	Supply Current (During Output Pulse)	$V_{CC} = 15V, Q1 = \text{Logic "1"},$ $Q2 = \text{Logic "0"}$ (Figure 4) $V_{CC} = 5V, Q1 = \text{Logic "1"},$ $Q2 = \text{Logic "0"}$ (Figure 4)		15 2		mA mA
	Leakage Current at R/C _{EXT} Pin	$V_{CC} = 15V, V_{C_{EXT}} = 5V$		0.01	3.0	μA
CMOS/LPTTL Interface						
$V_{IN(1)}$	Logical "1" Input Voltage	$V_{CC} = 4.75V$	$V_{CC} - 1.5$			V
$V_{IN(0)}$	Logical "0" Input Voltage	$V_{CC} = 4.75V$			0.8	V
$V_{OUT(1)}$	Logical "1" Output Voltage	$V_{CC} = 4.75V, I_O = -360 \mu A$	2.4			V
$V_{OUT(0)}$	Logical "0" Output Voltage	$V_{CC} = 4.75V, I_O = 360 \mu A$			0.4	V
Output Drive (See Family Characteristics Data Sheet) (Short Circuit Current)						
I_{SOURCE}	Output Source Current (P-Channel)	$V_{CC} = 5V$ $T_A = 25^\circ C, V_{OUT} = 0V$	-1.75			mA
I_{SOURCE}	Output Source Current (P-Channel)	$V_{CC} = 10V$ $T_A = 25^\circ C, V_{OUT} = 0V$	-8			mA
I_{SINK}	Output Sink Current (N-Channel)	$V_{CC} = 5V$ $T_A = 25^\circ C, V_{OUT} = V_{CC}$	1.75			mA
I_{SINK}	Output Sink Current (N-Channel)	$V_{CC} = 10V$ $T_A = 25^\circ C, V_{OUT} = V_{CC}$	8			mA

Note 2: In Standby (Q = Logic "0") the power dissipated equals the leakage current plus V_{CC}/R_{EXT} .

AC Electrical Characteristics (Note 3)						
$T_A = 25^\circ\text{C}$, $C_L = 50\text{ pF}$, unless otherwise noted						
Symbol	Parameter	Conditions	Min	Typ	Max	Units
$t_{pd\ A, B}$	Propagation Delay from Trigger Input (A, B) to Output Q, \bar{Q}	$V_{CC} = 5\text{V}$		250	500	ns
		$V_{CC} = 10\text{V}$		120	250	ns
$t_{pd\ CL}$	Propagation Delay from Clear Input (CL) to Output Q, \bar{Q}	$V_{CC} = 5\text{V}$		250	500	ns
		$V_{CC} = 10\text{V}$		120	250	ns
t_S	Time Prior to Trigger Input (A, B) that Clear must be Set	$V_{CC} = 5\text{V}$	150	50		ns
		$V_{CC} = 10\text{V}$	60	20		ns
$t_{W(A, B)}$	Trigger Input (A, B) Pulse Width	$V_{CC} = 5\text{V}$	150	50		ns
		$V_{CC} = 10\text{V}$	70	30		ns
$t_{W(CL)}$	Clear Input (CL) Pulse Width	$V_{CC} = 5\text{V}$	150	50		ns
		$V_{CC} = 10\text{V}$	70	30		ns
$t_{W(OUT)}$	Q or \bar{Q} Output Pulse Width	$V_{CC} = 5\text{V}$, $R_{EXT} = 10\text{k}$, $C_{EXT} = 0\text{ pF}$		900		ns
		$V_{CC} = 10\text{V}$, $R_{EXT} = 10\text{k}$, $C_{EXT} = 0\text{ pF}$		350		ns
		$V_{CC} = 15\text{V}$, $R_{EXT} = 10\text{k}$, $C_{EXT} = 0\text{ pF}$		320		ns
		$V_{CC} = 5\text{V}$, $R_{EXT} = 10\text{k}$, $C_{EXT} = 1000\text{ pF}$ (Figure 1)	9.0	10.6	12.2	μs
		$V_{CC} = 10\text{V}$, $R_{EXT} = 10\text{k}$, $C_{EXT} = 1000\text{ pF}$ (Figure 1)	9.0	10	11	μs
		$V_{CC} = 15\text{V}$, $R_{EXT} = 10\text{k}$, $C_{EXT} = 1000\text{ pF}$ (Figure 1)	8.9	9.8	10.8	μs
		$V_{CC} = 5\text{V}$, $R_{EXT} = 10\text{k}$, $C_{EXT} = 0.1\text{ }\mu\text{F}$ (Figure 3)	900	1020	1200	μs
		$V_{CC} = 10\text{V}$, $R_{EXT} = 10\text{k}$, $C_{EXT} = 0.1\text{ }\mu\text{F}$ (Figure 3)	900	1000	1100	μs
		$V_{CC} = 15\text{V}$, $R_{EXT} = 10\text{k}$, $C_{EXT} = 0.1\text{ }\mu\text{F}$ (Figure 3)	900	990	1100	μs
		R_{ON}	ON Resistance of Transistor between R/ C_{EXT} to C_{EXT}	$V_{CC} = 5\text{V}$ (Note 4)		50
$V_{CC} = 10\text{V}$ (Note 4)				25	65	Ω
$V_{CC} = 15\text{V}$ (Note 4)				16.7	45	Ω
	Output Duty Cycle	$R = 10\text{k}$, $C = 1000\text{ pF}$			90	%
		$R = 10\text{k}$, $C = 0.1\text{ }\mu\text{F}$ (Note 5)			90	%
C_{IN}	Input Capacitance	R/ C_{EXT} Input (Note 6)		15	25	pF
		Any Other Input (Note 6)		5		pF
<p>Note 3: AC Parameters are guaranteed by DC correlated testing.</p> <p>Note 4: See AN-138 for detailed explanation R_{ON}.</p> <p>Note 5: Maximum output duty cycle = $R_{EXT}/R_{EXT} + 1000$.</p> <p>Note 6: Capacitance is guaranteed by periodic testing.</p>						

Typical Performance Characteristics

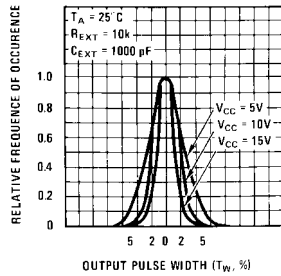

0% Point pulse width:
 At $V_{CC} = 5V$, $T_W = 10.6 \mu\text{s}$
 At $V_{CC} = 10V$, $T_W = 10 \mu\text{s}$
 At $V_{CC} = 15V$, $T_W = 9.8 \mu\text{s}$
 Percentage of units within +4%:
 At $V_{CC} = 5V$, 90% of units
 At $V_{CC} = 10V$, 95% of units
 At $V_{CC} = 15V$, 98% of units

FIGURE 1. Typical Distribution of Units for Output Pulse Width

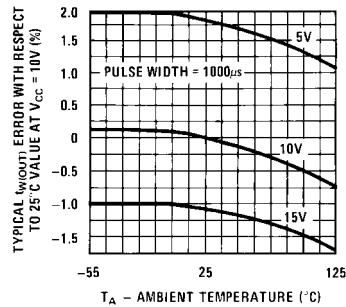
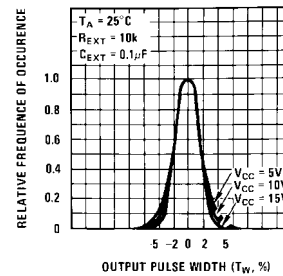

FIGURE 2. Typical Variation in Output Pulse Width vs Temperature



0% Point pulse width:
 At $V_{CC} = 5V$, $T_W = 1020 \mu\text{s}$
 At $V_{CC} = 10V$, $T_W = 1000 \mu\text{s}$
 At $V_{CC} = 15V$, $T_W = 982 \mu\text{s}$
 Percentage of units within +4%:
 At $V_{CC} = 5V$, 95% of units
 At $V_{CC} = 10V$, 97% of units
 At $V_{CC} = 15V$, 98% of units

FIGURE 3. Typical Distribution of Units for Output Pulse Width

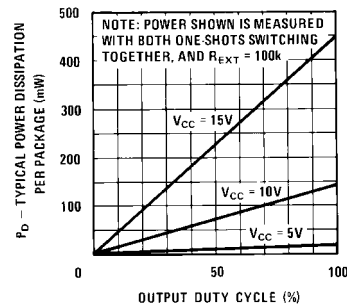
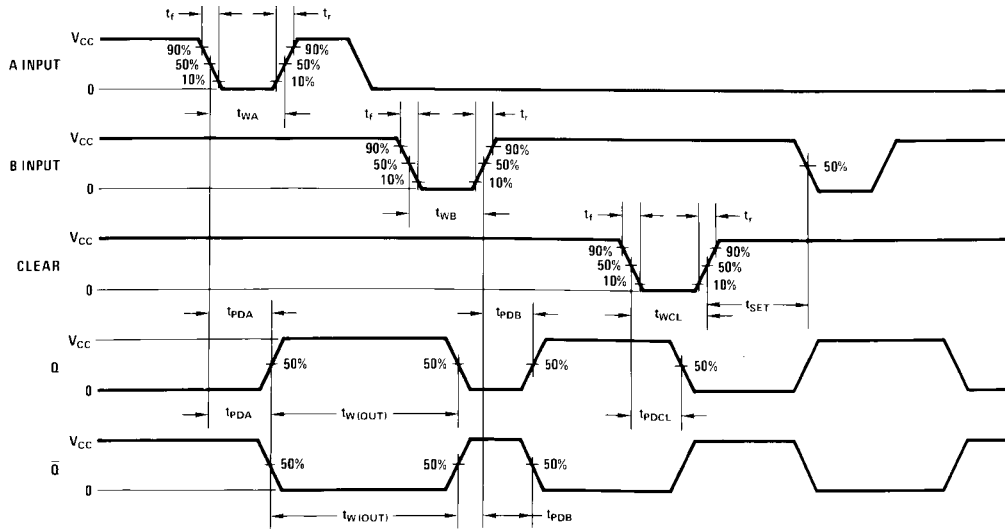

FIGURE 4. Typical Power Dissipation per Package

Typical Performance Characteristics (Continued)
Switching Time Waveforms



$t_r = t_f = 20 \text{ ns}$

Physical Dimensions inches (millimeters) unless otherwise noted

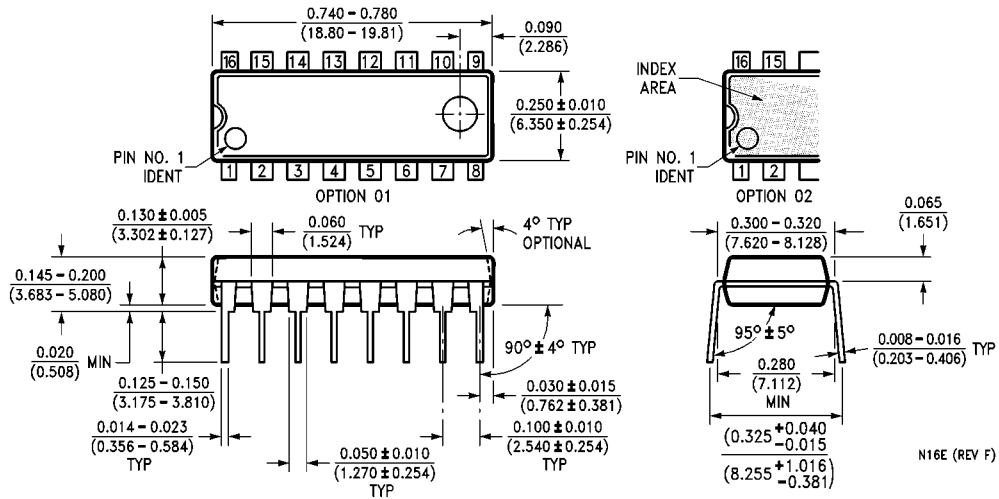

16-Lead Plastic Dual-In-Line Package (PDIP), JEDEC MS-001, 0.300" Wide
Package Number N16E

LIFE SUPPORT POLICY

FAIRCHILD'S PRODUCTS ARE NOT AUTHORIZED FOR USE AS CRITICAL COMPONENTS IN LIFE SUPPORT DEVICES OR SYSTEMS WITHOUT THE EXPRESS WRITTEN APPROVAL OF THE PRESIDENT OF FAIRCHILD SEMICONDUCTOR CORPORATION. As used herein:

1. Life support devices or systems are devices or systems which, (a) are intended for surgical implant into the body, or (b) support or sustain life, and (c) whose failure to perform when properly used in accordance with instructions for use provided in the labeling, can be reasonably expected to result in a significant injury to the user.
2. A critical component in any component of a life support device or system whose failure to perform can be reasonably expected to cause the failure of the life support device or system, or to affect its safety or effectiveness.

www.fairchildsemi.com